

BLF188XR; BLF188XRS

Power LDMOS transistor

Rev. 4 — 30 October 2013

Product data sheet

1. Product profile

1.1 General description

A 1400 W extremely rugged LDMOS power transistor for broadcast and industrial applications in the HF to 600 MHz band.

Table 1. Application information

Test signal	f (MHz)	V _{DS} (V)	P _L (W)	G _p (dB)	η _D (%)
CW	2 to 30	50	1270	29.0	75
	27	50	1400	23.7	73
	41	50	1200	22.0	82
	60	48	1240	22.0	77
	72.5	50	1350	23.1	83
	81.4	50	1200	27.1	77.8
	88 to 108	50	1320	22.5	85
	108	50	1200	26.5	83
	200	50	1288	19.3	68.3
pulsed RF	81.4	50	1200	25.8	85
	81.4	50	1400	25.4	81
	108	50	1400	24.0	73
DVB-T	174 to 230	50	225	23.8	29

1.2 Features and benefits

- Easy power control
- Integrated ESD protection
- Excellent ruggedness
- High efficiency
- Excellent thermal stability
- Designed for broadband operation (HF to 600 MHz)
- Compliant to Directive 2002/95/EC, regarding Restriction of Hazardous Substances (RoHS)

1.3 Applications

- Industrial, scientific and medical applications
- Broadcast transmitter applications



2. Pinning information

Table 2. Pinning

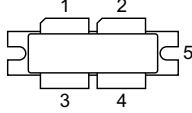
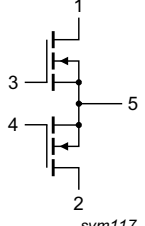
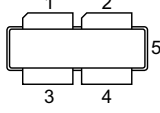
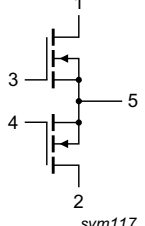
Pin	Description	Simplified outline	Graphic symbol
BLF188XR (SOT539A)			
1	drain1		 sym117
2	drain2		
3	gate1		
4	gate2		
5	source		
BLF188XRS (SOT539B)			
1	drain1		 sym117
2	drain2		
3	gate1		
4	gate2		
5	source		

[1] Connected to flange.

3. Ordering information

Table 3. Ordering information

Type number	Package		
	Name	Description	Version
BLF188XR	-	flanged balanced ceramic package; 2 mounting holes; 4 leads	SOT539A
BLF188XRS	-	earless flanged balanced ceramic package; 4 leads	SOT539B

4. Limiting values

Table 4. Limiting values

In accordance with the Absolute Maximum Rating System (IEC 60134).

Symbol	Parameter	Conditions	Min	Max	Unit
V_{DS}	drain-source voltage		-	135	V
V_{GS}	gate-source voltage		-6	+11	V
T_{stg}	storage temperature		-65	+150	°C
T_j	junction temperature		[1]	225	°C

[1] Continuous use at maximum temperature will affect the reliability, for details refer to the on-line MTF calculator

5. Thermal characteristics

Table 5. Thermal characteristics

Symbol	Parameter	Conditions	Typ	Unit
$R_{th(j-c)}$	thermal resistance from junction to case	$T_j = 150\text{ °C}$	[1][2] 0.10	K/W
$Z_{th(j-c)}$	transient thermal impedance from junction to case	$T_j = 150\text{ °C}; t_p = 100\text{ }\mu\text{s}; \delta = 20\text{ %}$	[3] 0.03	K/W

[1] T_j is the junction temperature.

[2] $R_{th(j-c)}$ is measured under RF conditions.

[3] See [Figure 1](#).

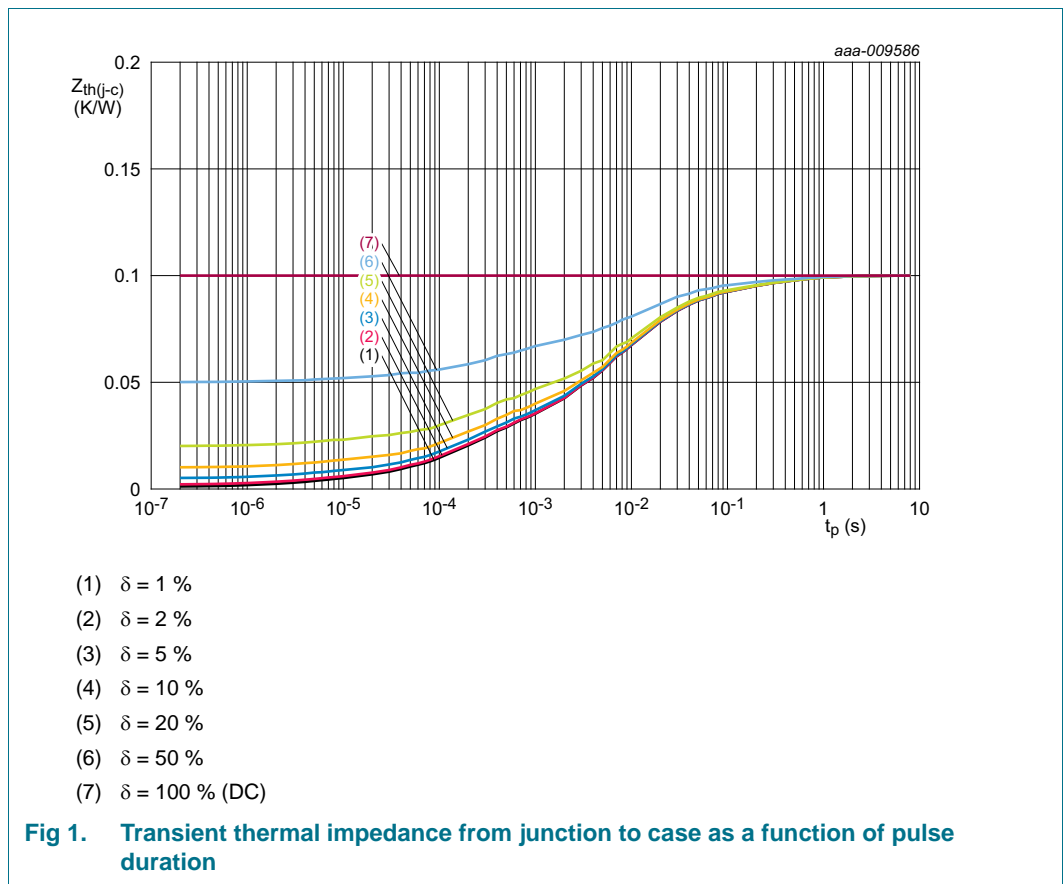

6. Characteristics

Table 6. DC characteristics

$T_j = 25\text{ °C};$ per section unless otherwise specified.

Symbol	Parameter	Conditions	Min	Typ	Max	Unit
$V_{(BR)DSS}$	drain-source breakdown voltage	$V_{GS} = 0\text{ V}; I_D = 5.5\text{ mA}$	135	-	-	V
$V_{GS(th)}$	gate-source threshold voltage	$V_{DS} = 10\text{ V}; I_D = 550\text{ mA}$	1.25	1.9	2.25	V
V_{GSq}	gate-source quiescent voltage	$V_{DS} = 50\text{ V}; I_D = 20\text{ mA}$	0.68	1.5	1.88	V

Table 6. DC characteristics ...continued

$T_j = 25\text{ }^\circ\text{C}$; per section unless otherwise specified.

Symbol	Parameter	Conditions	Min	Typ	Max	Unit
I_{DSS}	drain leakage current	$V_{GS} = 0\text{ V}; V_{DS} = 50\text{ V}$	-	-	2.8	μA
I_{DSX}	drain cut-off current	$V_{GS} = V_{GS(th)} + 3.75\text{ V}; V_{DS} = 10\text{ V}$	-	77	-	A
I_{GSS}	gate leakage current	$V_{GS} = 11\text{ V}; V_{DS} = 0\text{ V}$	-	-	280	nA
$R_{DS(on)}$	drain-source on-state resistance	$V_{GS} = V_{GS(th)} + 3.75\text{ V}; I_D = 19.25\text{ A}$	-	0.08	-	Ω

Table 7. AC characteristics

$T_j = 25\text{ }^\circ\text{C}$; per section unless otherwise specified.

Symbol	Parameter	Conditions	Min	Typ	Max	Unit
C_{rs}	feedback capacitance	$V_{GS} = 0\text{ V}; V_{DS} = 50\text{ V}; f = 1\text{ MHz}$	-	6.2	-	pF
C_{iss}	input capacitance	$V_{GS} = 0\text{ V}; V_{DS} = 50\text{ V}; f = 1\text{ MHz}$	-	582	-	pF
C_{oss}	output capacitance	$V_{GS} = 0\text{ V}; V_{DS} = 50\text{ V}; f = 1\text{ MHz}$	-	212	-	pF

Table 8. RF characteristics

Test signal: pulsed RF; $t_p = 100\text{ }\mu\text{s}$; $\delta = 10\%$; $f = 108\text{ MHz}$; RF performance at $V_{DS} = 50\text{ V}$; $I_{Dq} = 40\text{ mA}$; $T_{case} = 25\text{ }^\circ\text{C}$; unless otherwise specified; in a class-AB production test circuit.

Symbol	Parameter	Conditions	Min	Typ	Max	Unit
G_p	power gain	$P_L = 1400\text{ W}$	23.2	24.4	-	dB
RL_{in}	input return loss	$P_L = 1400\text{ W}$	-	-21	-14	dB
η_D	drain efficiency	$P_L = 1400\text{ W}$	69	73	-	%

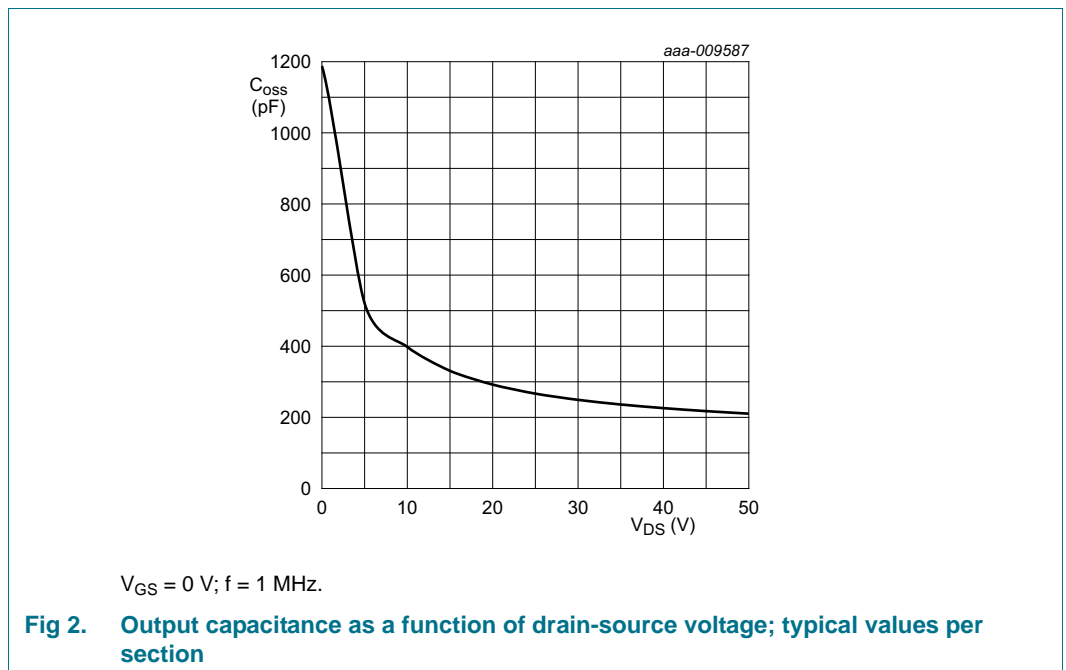

7. Test information

7.1 Ruggedness in class-AB operation

The BLF188XR and BLF188XRS are capable of withstanding a load mismatch corresponding to VSWR > 65 : 1 through all phases under the following conditions: $V_{DS} = 50\text{ V}$; $I_{DQ} = 40\text{ mA}$; $P_L = 1400\text{ W}$ pulsed; $f = 108\text{ MHz}$.

7.2 Impedance information

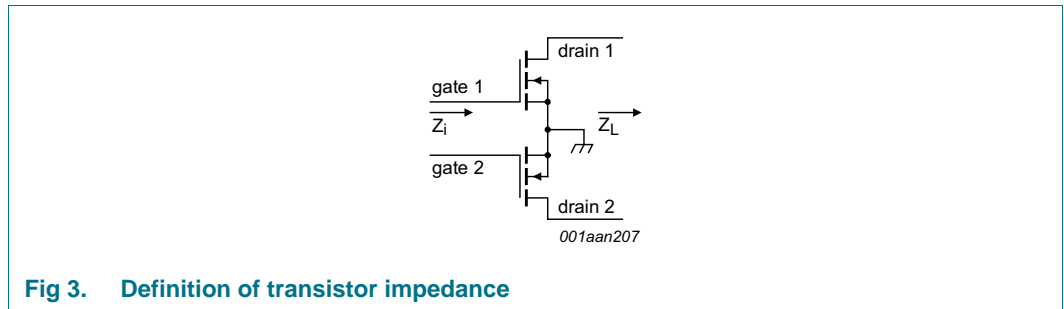

Fig 3. Definition of transistor impedance

Table 9. Typical push-pull impedance

Simulated Z_i and Z_L device impedance; impedance info at $V_{DS} = 50\text{ V}$ and $P_L = 1400\text{ W}$.

f (MHz)	Z_i (Ω)	Z_L (Ω)
108	$2.94 - j9.64$	$2.74 + j0.57$

7.3 Test circuit

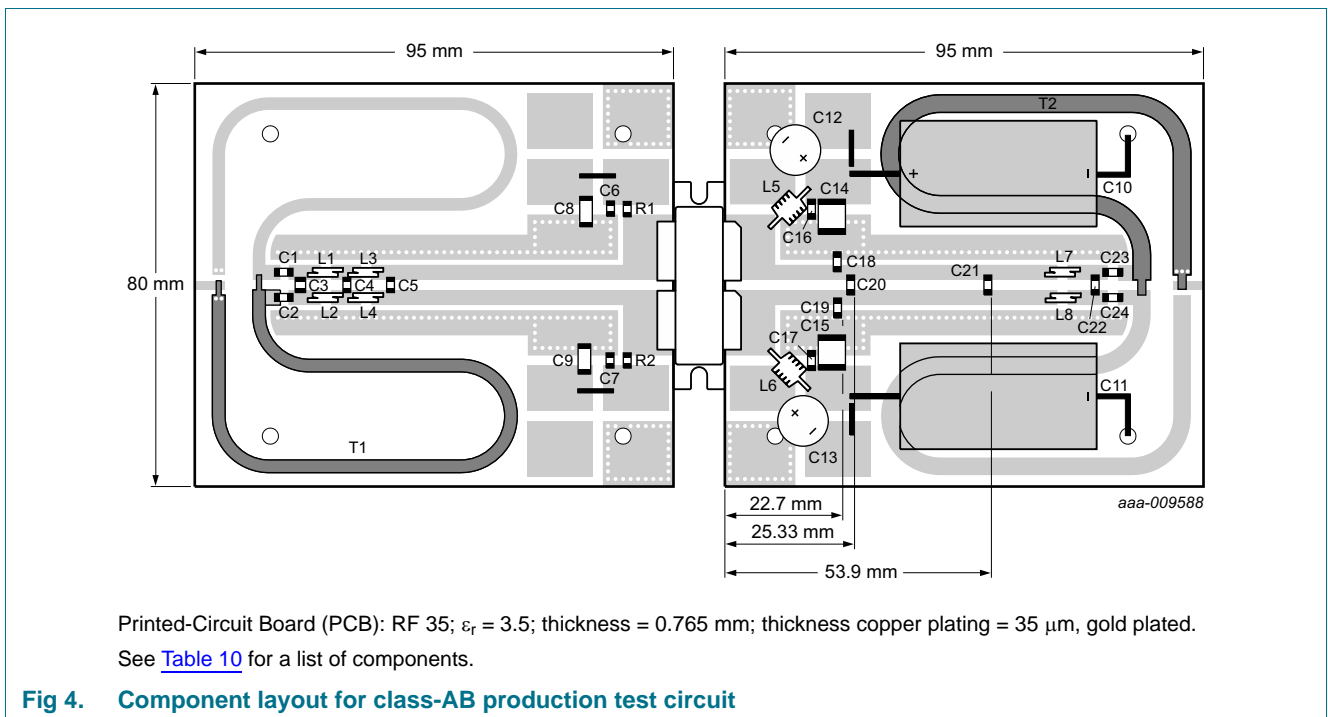

Printed-Circuit Board (PCB): RF 35; $\epsilon_r = 3.5$; thickness = 0.765 mm; thickness copper plating = 35 μm , gold plated. See Table 10 for a list of components.

Fig 4. Component layout for class-AB production test circuit

Table 10. List of componentsFor test circuit see [Figure 4](#).

Component	Description	Value	Remarks
C1, C2, C6, C7, C16, C17, C23, C24	multilayer ceramic chip capacitor	1000 pF	[1]
C3	multilayer ceramic chip capacitor	47 pF	[2]
C4	multilayer ceramic chip capacitor	39 pF	[1]
C5	multilayer ceramic chip capacitor	200 pF	[1]
C8, C9, C14, C15	multilayer ceramic chip capacitor	4.7 μ F, 100 V	TDK C5750X7R2A475KT
C10, C11	electrolytic capacitor	2200 μ F, 63 V	
C12, C13	electrolytic capacitor	470 μ F, 63 V	
C18, C19	multilayer ceramic chip capacitor	120 pF	[1]
C20	multilayer ceramic chip capacitor	82 pF	[1]
C21	multilayer ceramic chip capacitor	120 pF	[1]
C22	multilayer ceramic chip capacitor	56 pF	[1]
L1, L2, L3, L4	1.5 turn 0.8 mm copper wire	D = 3.2 mm, length = 1.6 mm	
L5, L6	5.0 turn 0.8 mm copper wire	D = 3.0 mm, length = 4 mm	
L7, L8	2.5 turn 0.8 mm copper wire	D = 3.0 mm, length = 2.4 mm	
R1, R2	resistor	9.1 Ω	SMD 1206
T1	semi rigid coax	25 Ω , length = 160 mm	Micro-Coax UT-090C-25
T2	semi rigid coax	25 Ω , length = 160 mm	Micro-Coax UT-141C-25

[1] American Technical Ceramics type 800B or capacitor of same quality.

[2] American Technical Ceramics type 100B or capacitor of same quality.

7.4 Graphical data

The following figures are measured in a class-AB production test circuit.

7.4.1 1-Tone CW pulsed

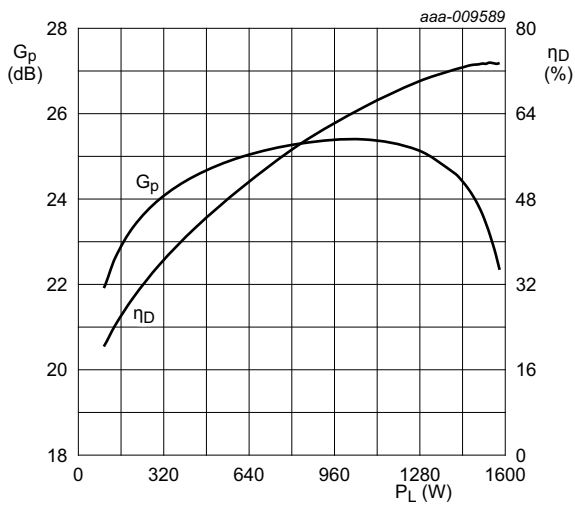

$V_{DS} = 50 \text{ V}$; $I_{Dq} = 40 \text{ mA}$; $f = 108 \text{ MHz}$; $t_p = 100 \text{ }\mu\text{s}$;
 $\delta = 20 \text{ }\%$.

Fig 5. Power gain and drain efficiency as function of output power; typical values

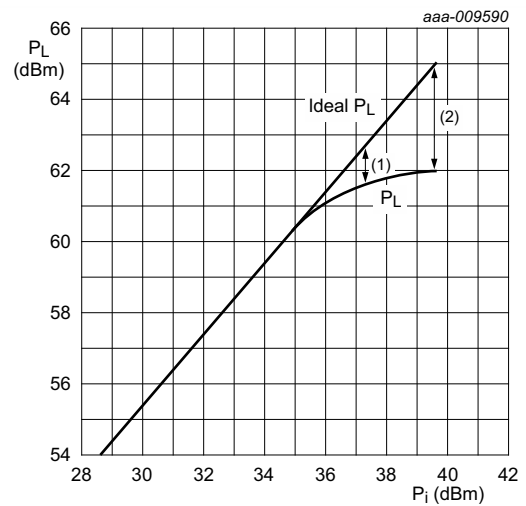

$V_{DS} = 50 \text{ V}$; $I_{Dq} = 40 \text{ mA}$; $f = 108 \text{ MHz}$; $t_p = 100 \text{ }\mu\text{s}$;
 $\delta = 20 \text{ }\%$.

- (1) $P_{L(1dB)} = 61.58 \text{ dBm}$ (1440 W)
- (2) $P_{L(3dB)} = 61.98 \text{ dBm}$ (1580 W)

Fig 6. Output power as a function of input power; typical values

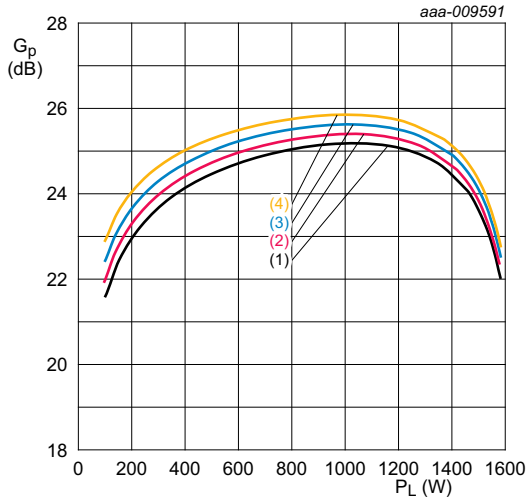

$V_{DS} = 50\text{ V}$; $f = 108\text{ MHz}$; $t_p = 100\text{ }\mu\text{s}$; $\delta = 20\text{ }\%$.

- (1) $I_{Dq} = 20\text{ mA}$
- (2) $I_{Dq} = 40\text{ mA}$
- (3) $I_{Dq} = 80\text{ mA}$
- (4) $I_{Dq} = 160\text{ mA}$

Fig 7. Power gain as a function of output power; typical values

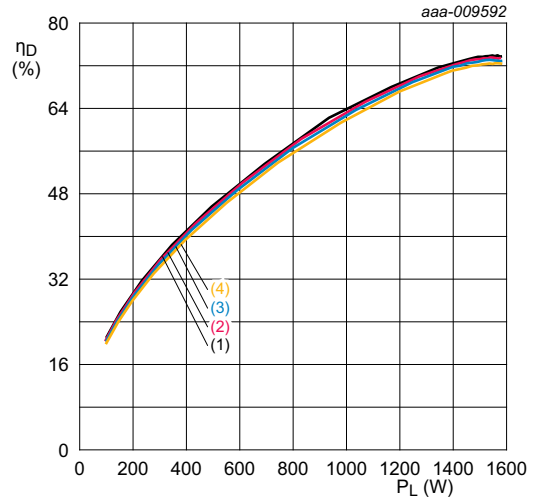

$V_{DS} = 50\text{ V}$; $f = 108\text{ MHz}$; $t_p = 100\text{ }\mu\text{s}$; $\delta = 20\text{ }\%$.

- (1) $I_{Dq} = 20\text{ mA}$
- (2) $I_{Dq} = 40\text{ mA}$
- (3) $I_{Dq} = 80\text{ mA}$
- (4) $I_{Dq} = 160\text{ mA}$

Fig 8. Drain efficiency as a function of output power; typical values

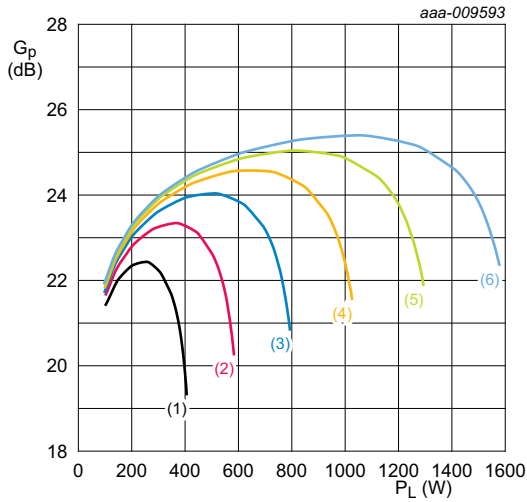

$I_{Dq} = 40\text{ mA}$; $f = 108\text{ MHz}$; $t_p = 100\text{ }\mu\text{s}$; $\delta = 20\text{ }\%$.

- (1) $V_{DS} = 25\text{ V}$
- (2) $V_{DS} = 30\text{ V}$
- (3) $V_{DS} = 35\text{ V}$
- (4) $V_{DS} = 40\text{ V}$
- (5) $V_{DS} = 45\text{ V}$
- (6) $V_{DS} = 50\text{ V}$

Fig 9. Power gain as a function of output power; typical values

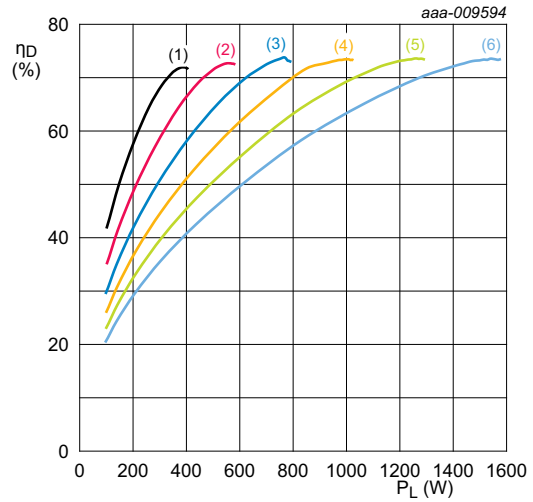

$I_{Dq} = 40\text{ mA}$; $f = 108\text{ MHz}$; $t_p = 100\text{ }\mu\text{s}$; $\delta = 20\text{ }\%$.

- (1) $V_{DS} = 25\text{ V}$
- (2) $V_{DS} = 30\text{ V}$
- (3) $V_{DS} = 35\text{ V}$
- (4) $V_{DS} = 40\text{ V}$
- (5) $V_{DS} = 45\text{ V}$
- (6) $V_{DS} = 50\text{ V}$

Fig 10. Drain efficiency as a function of output power; typical values

8. Package outline

Flanged balanced ceramic package; 2 mounting holes; 4 leads

SOT539A

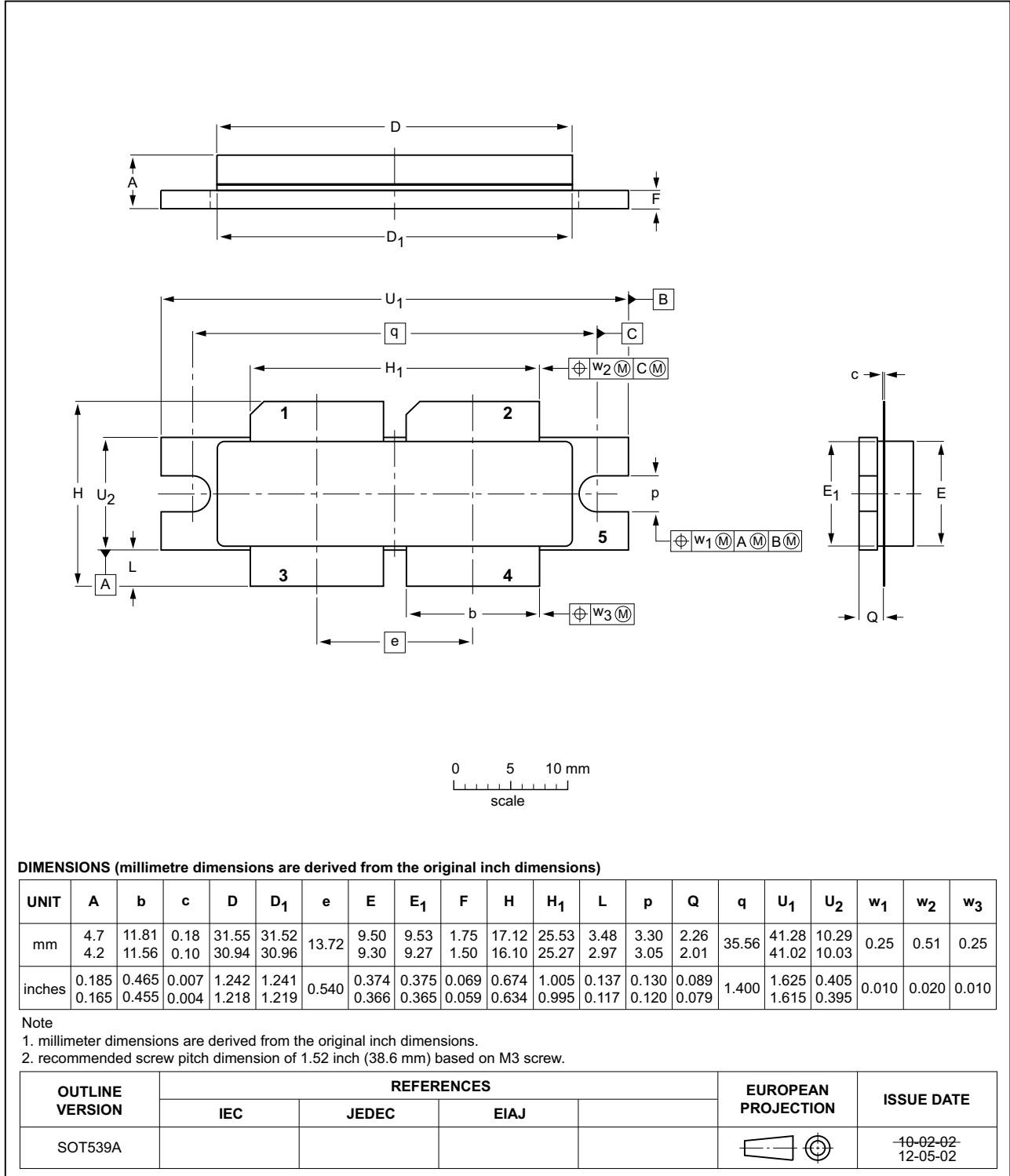

Fig 11. Package outline SOT539A

Earless flanged balanced ceramic package; 4 leads

SOT539B

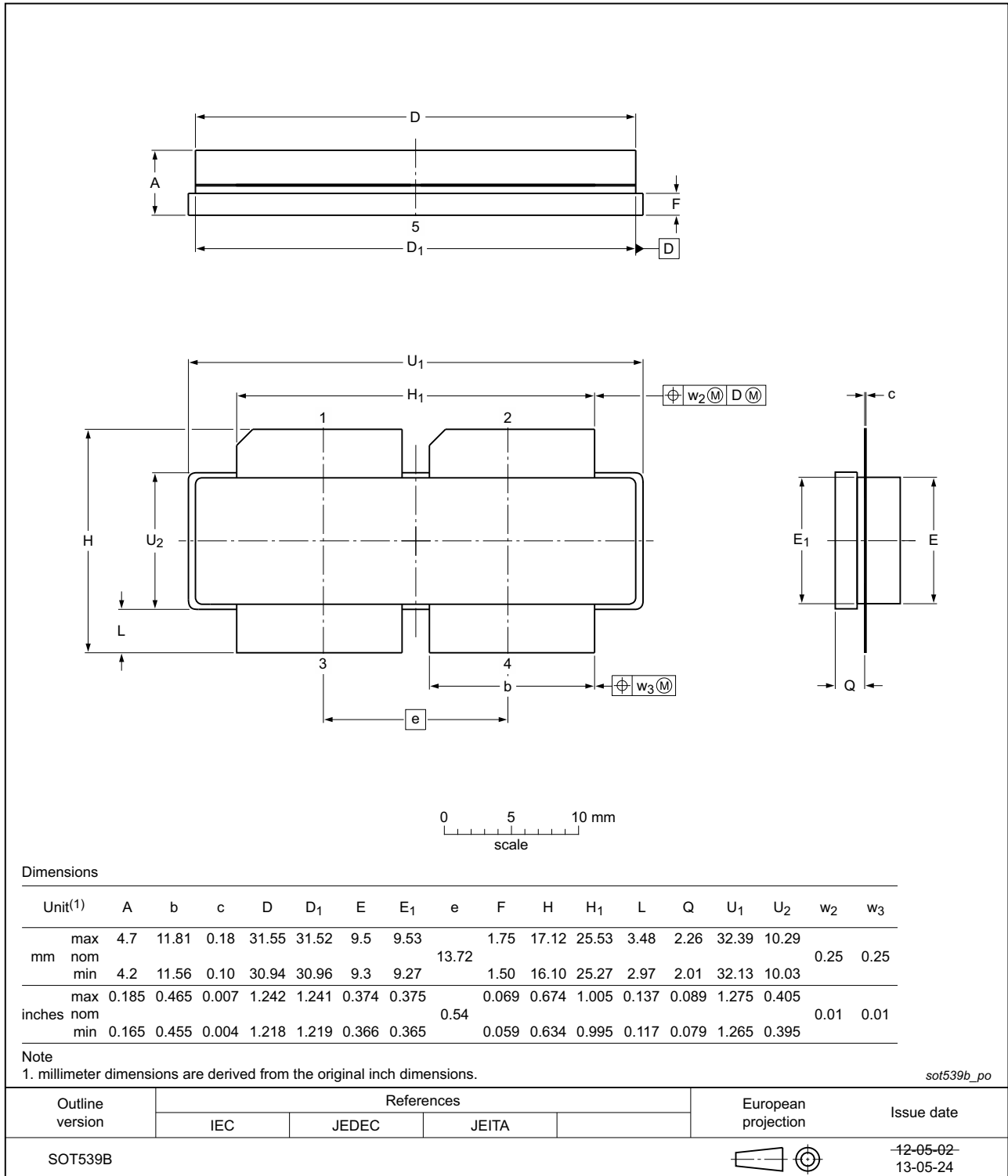

Fig 12. Package outline SOT539B

9. Handling information

CAUTION



This device is sensitive to ElectroStatic Discharge (ESD). Observe precautions for handling electrostatic sensitive devices.

Such precautions are described in the *ANSI/ESD S20.20*, *IEC/ST 61340-5*, *JESD625-A* or equivalent standards.

10. Abbreviations

Table 11. Abbreviations

Acronym	Description
CW	Continuous Wave
DVB-T	Digital Video Broadcast - Terrestrial
ESD	ElectroStatic Discharge
HF	High Frequency
LDMOS	Laterally Diffused Metal-Oxide Semiconductor
MTF	Median Time to Failure
SMD	Surface Mounted Device
VSWR	Voltage Standing-Wave Ratio

11. Revision history

Table 12. Revision history

Document ID	Release date	Data sheet status	Change notice	Supersedes
BLF188XR_BLF188XRS v.4	20131030	Product data sheet	-	BLF188XR_BLF188XRS v.3
Modifications		<ul style="list-style-type: none"> • Table 1 on page 1: table updated • Table 4 on page 2: table updated • Table 5 on page 3: table updated • Figure 1 on page 3: figure added • Table 6 on page 3: table updated • Table 7 on page 4: table updated • Table 8 on page 4: table updated • Figure 2 on page 4: figure added • Section 7.3 on page 5: section added • Section 7.4 on page 7: section added 		
BLF188XR_BLF188XRS v.3	20130801	Objective data sheet	-	BLF188XR_BLF188XRS v.2
BLF188XR_BLF188XRS v.2	20130712	Objective data sheet	-	BLF188XR_BLF188XRS v.1
BLF188XR_BLF188XRS v.1	20130506	Objective data sheet	-	-

12. Legal information

12.1 Data sheet status

Document status ^{[1][2]}	Product status ^[3]	Definition
Objective [short] data sheet	Development	This document contains data from the objective specification for product development.
Preliminary [short] data sheet	Qualification	This document contains data from the preliminary specification.
Product [short] data sheet	Production	This document contains the product specification.

[1] Please consult the most recently issued document before initiating or completing a design.

[2] The term 'short data sheet' is explained in section "Definitions".

[3] The product status of device(s) described in this document may have changed since this document was published and may differ in case of multiple devices. The latest product status information is available on the Internet at URL <http://www.nxp.com>.

12.2 Definitions

Draft — The document is a draft version only. The content is still under internal review and subject to formal approval, which may result in modifications or additions. NXP Semiconductors does not give any representations or warranties as to the accuracy or completeness of information included herein and shall have no liability for the consequences of use of such information.

Short data sheet — A short data sheet is an extract from a full data sheet with the same product type number(s) and title. A short data sheet is intended for quick reference only and should not be relied upon to contain detailed and full information. For detailed and full information see the relevant full data sheet, which is available on request via the local NXP Semiconductors sales office. In case of any inconsistency or conflict with the short data sheet, the full data sheet shall prevail.

Product specification — The information and data provided in a Product data sheet shall define the specification of the product as agreed between NXP Semiconductors and its customer, unless NXP Semiconductors and customer have explicitly agreed otherwise in writing. In no event however, shall an agreement be valid in which the NXP Semiconductors product is deemed to offer functions and qualities beyond those described in the Product data sheet.

12.3 Disclaimers

Limited warranty and liability — Information in this document is believed to be accurate and reliable. However, NXP Semiconductors does not give any representations or warranties, expressed or implied, as to the accuracy or completeness of such information and shall have no liability for the consequences of use of such information. NXP Semiconductors takes no responsibility for the content in this document if provided by an information source outside of NXP Semiconductors.

In no event shall NXP Semiconductors be liable for any indirect, incidental, punitive, special or consequential damages (including - without limitation - lost profits, lost savings, business interruption, costs related to the removal or replacement of any products or rework charges) whether or not such damages are based on tort (including negligence), warranty, breach of contract or any other legal theory.

Notwithstanding any damages that customer might incur for any reason whatsoever, NXP Semiconductors' aggregate and cumulative liability towards customer for the products described herein shall be limited in accordance with the *Terms and conditions of commercial sale* of NXP Semiconductors.

Right to make changes — NXP Semiconductors reserves the right to make changes to information published in this document, including without limitation specifications and product descriptions, at any time and without notice. This document supersedes and replaces all information supplied prior to the publication hereof.

Suitability for use — NXP Semiconductors products are not designed, authorized or warranted to be suitable for use in life support, life-critical or safety-critical systems or equipment, nor in applications where failure or malfunction of an NXP Semiconductors product can reasonably be expected to result in personal injury, death or severe property or environmental damage. NXP Semiconductors and its suppliers accept no liability for inclusion and/or use of NXP Semiconductors products in such equipment or applications and therefore such inclusion and/or use is at the customer's own risk.

Applications — Applications that are described herein for any of these products are for illustrative purposes only. NXP Semiconductors makes no representation or warranty that such applications will be suitable for the specified use without further testing or modification.

Customers are responsible for the design and operation of their applications and products using NXP Semiconductors products, and NXP Semiconductors accepts no liability for any assistance with applications or customer product design. It is customer's sole responsibility to determine whether the NXP Semiconductors product is suitable and fit for the customer's applications and products planned, as well as for the planned application and use of customer's third party customer(s). Customers should provide appropriate design and operating safeguards to minimize the risks associated with their applications and products.

NXP Semiconductors does not accept any liability related to any default, damage, costs or problem which is based on any weakness or default in the customer's applications or products, or the application or use by customer's third party customer(s). Customer is responsible for doing all necessary testing for the customer's applications and products using NXP Semiconductors products in order to avoid a default of the applications and the products or of the application or use by customer's third party customer(s). NXP does not accept any liability in this respect.

Limiting values — Stress above one or more limiting values (as defined in the Absolute Maximum Ratings System of IEC 60134) will cause permanent damage to the device. Limiting values are stress ratings only and (proper) operation of the device at these or any other conditions above those given in the Recommended operating conditions section (if present) or the Characteristics sections of this document is not warranted. Constant or repeated exposure to limiting values will permanently and irreversibly affect the quality and reliability of the device.

Terms and conditions of commercial sale — NXP Semiconductors products are sold subject to the general terms and conditions of commercial sale, as published at <http://www.nxp.com/profile/terms>, unless otherwise agreed in a valid written individual agreement. In case an individual agreement is concluded only the terms and conditions of the respective agreement shall apply. NXP Semiconductors hereby expressly objects to applying the customer's general terms and conditions with regard to the purchase of NXP Semiconductors products by customer.

No offer to sell or license — Nothing in this document may be interpreted or construed as an offer to sell products that is open for acceptance or the grant, conveyance or implication of any license under any copyrights, patents or other industrial or intellectual property rights.

Export control — This document as well as the item(s) described herein may be subject to export control regulations. Export might require a prior authorization from competent authorities.

Non-automotive qualified products — Unless this data sheet expressly states that this specific NXP Semiconductors product is automotive qualified, the product is not suitable for automotive use. It is neither qualified nor tested in accordance with automotive testing or application requirements. NXP Semiconductors accepts no liability for inclusion and/or use of non-automotive qualified products in automotive equipment or applications.

In the event that customer uses the product for design-in and use in automotive applications to automotive specifications and standards, customer (a) shall use the product without NXP Semiconductors' warranty of the product for such automotive applications, use and specifications, and (b) whenever customer uses the product for automotive applications beyond NXP Semiconductors' specifications such use shall be solely at customer's own risk, and (c) customer fully indemnifies NXP Semiconductors for any liability, damages or failed product claims resulting from customer design and use of the product for automotive applications beyond NXP Semiconductors' standard warranty and NXP Semiconductors' product specifications.

Translations — A non-English (translated) version of a document is for reference only. The English version shall prevail in case of any discrepancy between the translated and English versions.

12.4 Licenses

ICs with DVB-T or DVB-T2 functionality

Use of this product in any manner that complies with the DVB-T or the DVB-T2 standard may require licenses under applicable patents of the DVB-T respectively the DVB-T2 patent portfolio, which license is available from Sisvel S.p.A., Via Sestriere 100, 10060 None (TO), Italy, and under applicable patents of other parties.

12.5 Trademarks

Notice: All referenced brands, product names, service names and trademarks are the property of their respective owners.

13. Contact information

For more information, please visit: <http://www.nxp.com>

For sales office addresses, please send an email to: salesaddresses@nxp.com

14. Contents

1	Product profile	1
1.1	General description	1
1.2	Features and benefits	1
1.3	Applications	1
2	Pinning information	2
3	Ordering information	2
4	Limiting values	2
5	Thermal characteristics	3
6	Characteristics	3
7	Test information	5
7.1	Ruggedness in class-AB operation	5
7.2	Impedance information	5
7.3	Test circuit	5
7.4	Graphical data	7
7.4.1	1-Tone CW pulsed	7
8	Package outline	9
9	Handling information	11
10	Abbreviations	11
11	Revision history	11
12	Legal information	12
12.1	Data sheet status	12
12.2	Definitions	12
12.3	Disclaimers	12
12.4	Licenses	13
12.5	Trademarks	13
13	Contact information	13
14	Contents	14

Please be aware that important notices concerning this document and the product(s) described herein, have been included in section 'Legal information'.

© NXP B.V. 2013. All rights reserved.

For more information, please visit: <http://www.nxp.com>
 For sales office addresses, please send an email to: salesaddresses@nxp.com

Date of release: 30 October 2013
 Document identifier: BLF188XR_BLF188XRS