

# BLF4G20-110B; BLF4G20S-110B

UHF power LDMOS transistor

Rev. 01 — 23 January 2006

Product data sheet

## 1. Product profile

### 1.1 General description

110 W LDMOS power transistor for base station applications at frequencies from 1800 MHz to 2000 MHz.

**Table 1: Typical performance**

$f = 1930 \text{ MHz to } 1990 \text{ MHz}$ ;  $T_{\text{case}} = 25^\circ \text{C}$ ; in a class-AB production test circuit.

Mode of operation	$V_{\text{DS}}$ (V)	$P_{\text{L}}$ (W)	$G_{\text{p}}$ (dB) (typ)	$\eta_{\text{D}}$ (%) (typ)	$\text{ACPR}_{400}$ (dBc) (typ)	$\text{ACPR}_{600}$ (dBc) (typ)	$\text{EVM}_{\text{rms}}$ (%) (typ)
CW	28	100	13.4	49	-	-	-
GSM EDGE	28	48 (AV)	13.8	38.5	-61 [1]	-74 [2]	2.1

[1]  $\text{ACPR}_{400}$  at 30 kHz resolution bandwidth.

[2]  $\text{ACPR}_{600}$  at 30 kHz resolution bandwidth.

### CAUTION



This device is sensitive to ElectroStatic Discharge (ESD). Therefore care should be taken during transport and handling.

### 1.2 Features

- Typical GSM EDGE performance at a frequency of 1930 MHz and 1990 MHz, a supply voltage of 28 V and an  $I_{\text{DQ}}$  of 650 mA:
  - ◆ Load power = 48 W (AV)
  - ◆ Gain = 13.8 dB (typ)
  - ◆ Efficiency = 38.5 % (typ)
  - ◆  $\text{ACPR}_{400} = -61$  dBc (typ)
  - ◆  $\text{ACPR}_{600} = -74$  dBc (typ)
  - ◆  $\text{EVM}_{\text{rms}} = 2.1$  % (typ)
- Easy power control
- Excellent ruggedness
- High efficiency
- Excellent thermal stability
- Designed for broadband operation (1800 MHz to 2000 MHz)

# PHILIPS

- Internally matched for ease of use

### 1.3 Applications

- RF power amplifiers for GSM, GSM EDGE and CDMA base stations and multicarrier applications in the 1800 MHz to 2000 MHz frequency range.

## 2. Pinning information

Table 2: Pinning

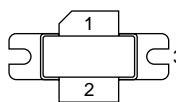
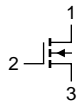
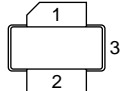
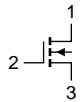
Pin	Description	Simplified outline	Symbol
<b>BLF4G20-110B (SOT502A)</b>			
1	drain		 sym039
2	gate		
3	source <a href="#">[1]</a>		
<b>BLF4G20S-110B (SOT502B)</b>			
1	drain		 sym039
2	gate		
3	source <a href="#">[1]</a>		

[1] Connected to flange

## 3. Ordering information

Table 3: Ordering information

Type number	Package		
	Name	Description	Version
BLF4G20-110B	-	flanged LDMOST ceramic package; 2 mounting holes; 2 leads	SOT502A
BLF4G20S-110B	-	earless flanged LDMOST ceramic package; 2 leads	SOT502B

## 4. Limiting values

**Table 4: Limiting values**

In accordance with the Absolute Maximum Rating System (IEC 60134).

Symbol	Parameter	Min	Max	Unit
$V_{DS}$	drain-source voltage	-	65	V
$V_{GS}$	gate-source voltage	-0.5	+15	V
$I_D$	drain current	-	12	A
$T_{stg}$	storage temperature	-65	+150	°C
$T_j$	junction temperature	-	200	°C

## 5. Thermal characteristics

**Table 5: Thermal characteristics**

Symbol	Parameter	Conditions	Min	Typ	Max	Unit
$R_{th(j-case)}$	thermal resistance from junction to case	$T_{case} = 80\text{ °C}$				
		$P_L = 40\text{ W}$	-	0.76	0.85	K/W
		$P_L = 100\text{ W}$	-	0.65	0.74	K/W

## 6. Characteristics

**Table 6: Characteristics**

$T_j = 25\text{ °C}$  unless otherwise specified.

Symbol	Parameter	Conditions	Min	Typ	Max	Unit
$V_{(BR)DSS}$	drain-source breakdown voltage	$V_{GS} = 0\text{ V}; I_D = 0.9\text{ mA}$	65	-	-	V
$V_{GS(th)}$	gate-source threshold voltage	$V_{DS} = 10\text{ V}; I_D = 180\text{ mA}$	2.5	3.1	3.5	V
$V_{GSq}$	gate-source quiescent voltage	$V_{DS} = 28\text{ V}; I_D = 900\text{ mA}$	2.7	3.2	3.7	V
$I_{DSS}$	drain leakage current	$V_{GS} = 0\text{ V}; V_{DS} = 28\text{ V}$	-	-	3	$\mu\text{A}$
$I_{DSX}$	drain cut-off current	$V_{GS} = V_{GS(th)} + 6\text{ V}; V_{DS} = 10\text{ V}$	27	30	-	A
$I_{GSS}$	gate leakage current	$V_{GS} = 15\text{ V}; V_{DS} = 0\text{ V}$	-	-	300	nA
$g_{fs}$	transfer conductance	$V_{DS} = 10\text{ V}; I_D = 10\text{ A}$	-	9.0	-	S
$R_{DS(on)}$	drain-source on-state resistance	$V_{GS} = V_{GS(th)} + 6\text{ V}; I_D = 6\text{ A}$	-	90	-	$\text{m}\Omega$
$C_{rs}$	feedback capacitance	$V_{GS} = 0\text{ V}; V_{DS} = 28\text{ V}; f = 1\text{ MHz}$	-	2.5	-	pF

## 7. Application information

**Table 7: Application information**

*Mode of operation: Two-tone (200 kHz tone spacing);  $f = 1930$  MHz and  $1990$  MHz.*

*$V_{DS} = 28$  V;  $I_{Dq} = 700$  mA;  $T_{case} = 25$  °C; unless otherwise specified; in a class-AB production test circuit.*

Symbol	Parameter	Conditions	Min	Typ	Max	Unit
$G_p$	power gain	$P_{L(AV)} = 100$ W	12	13.5	-	dB
IRL	input return loss	$P_{L(AV)} = 100$ W	-	-10	-6.5	dB
$\eta_D$	drain efficiency	$P_{L(AV)} = 100$ W	36	38.5	-	%
IMD3	third order intermodulation distortion	$P_{L(AV)} = 100$ W	-	-29	-26	dBc
IMD5	fifth order intermodulation distortion	$P_{L(AV)} = 100$ W	-	-39.5	-36.5	dBc
IMD7	seventh order intermodulation distortion	$P_{L(AV)} = 100$ W	-	-53.5	-50.5	dBc

### 7.1 Ruggedness in class-AB operation

The BLF4G20(S)-110B is capable of withstanding a load mismatch corresponding to  $V_{SWR} = 10 : 1$  through all phases under the following conditions:  $V_{DS} = 28$  V;  $I_{Dq} = 650$  mA;  $P_L = 110$  W (CW);  $f = 1990$  MHz.

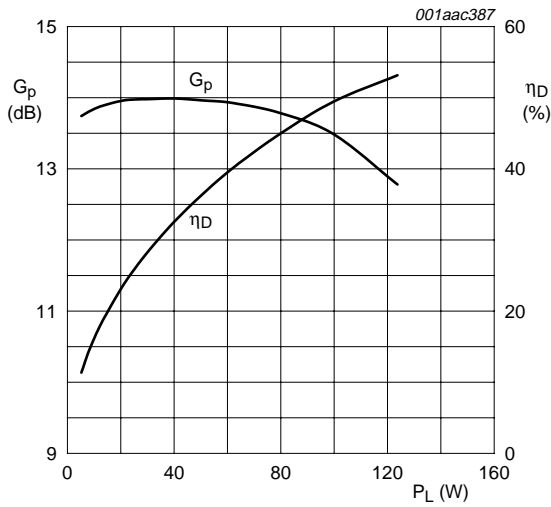

$V_{DS} = 28\text{ V}$ ;  $I_{Dq} = 650\text{ mA}$ ;  $T_{case} = 25\text{ }^{\circ}\text{C}$ ;  
 $f = 1990\text{ MHz}$

**Fig 1. One-tone CW power gain and drain efficiency as functions of load power; typical values**

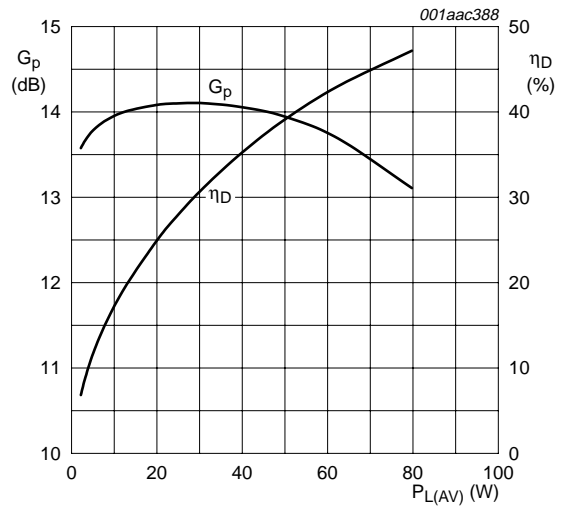

$V_{DS} = 28\text{ V}$ ;  $I_{Dq} = 650\text{ mA}$ ;  $T_{case} = 25\text{ }^{\circ}\text{C}$ ;  
 $f = 1990\text{ MHz}$

**Fig 2. Two-tone CW power gain and drain efficiency as functions of average load power; typical values**

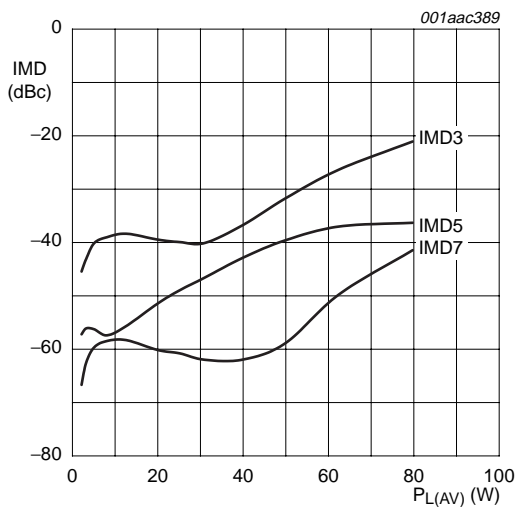

$V_{DS} = 28\text{ V}$ ;  $I_{Dq} = 650\text{ mA}$ ;  $T_{case} = 25\text{ }^{\circ}\text{C}$ ;  
 $f = 1990\text{ MHz}$

**Fig 3. Intermodulation distortion as a function of average load power; typical values**

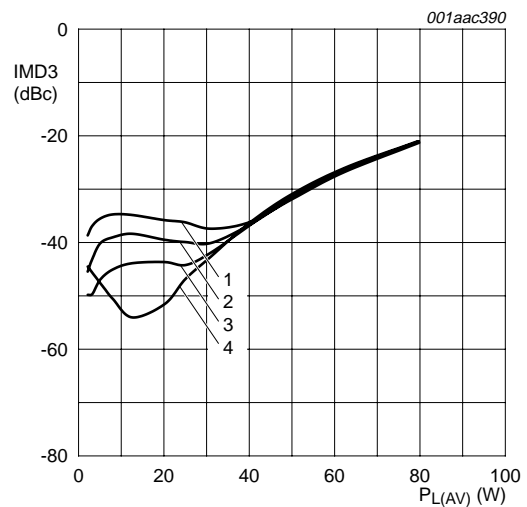

$V_{DS} = 28\text{ V}$ ;  $T_{case} = 25\text{ }^{\circ}\text{C}$ ;  $f = 1990\text{ MHz}$

- (1)  $I_{Dq} = 550\text{ mA}$
- (2)  $I_{Dq} = 650\text{ mA}$
- (3)  $I_{Dq} = 750\text{ mA}$
- (4)  $I_{Dq} = 850\text{ mA}$

**Fig 4. Third order intermodulation distortion as a function of average load power; typical values**

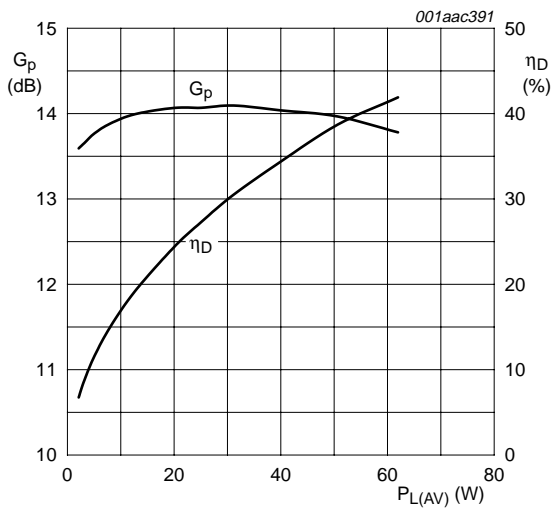

$V_{DS} = 28\text{ V}$ ;  $I_{Dq} = 650\text{ mA}$ ;  $T_{case} = 25\text{ }^\circ\text{C}$ ;  
 $f = 1990\text{ MHz}$

**Fig 5. GSM EDGE power gain and drain efficiency as functions of average load power; typical values**

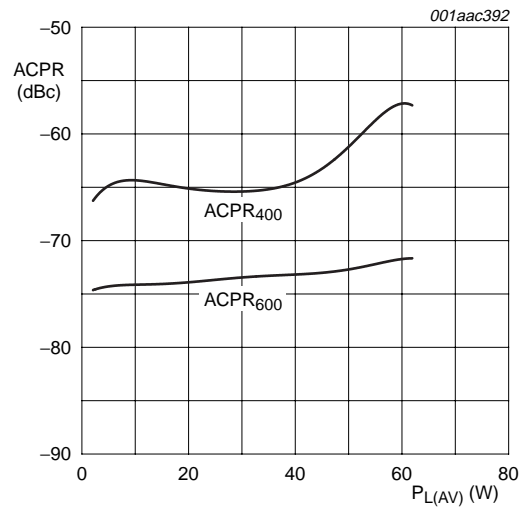

$V_{DS} = 28\text{ V}$ ;  $I_{Dq} = 650\text{ mA}$ ;  $T_{case} = 25\text{ }^\circ\text{C}$ ;  
 $f = 1990\text{ MHz}$

**Fig 6. GSM EDGE ACPR at 400 kHz and at 600 kHz as functions of average load power; typical values**

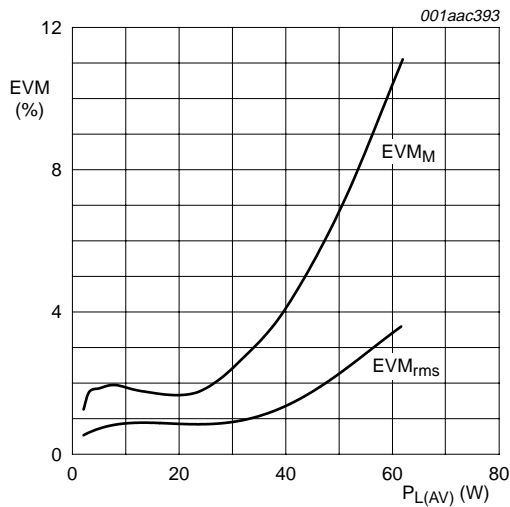

$V_{DS} = 28\text{ V}$ ;  $I_{Dq} = 650\text{ mA}$ ;  $T_{case} = 25\text{ }^\circ\text{C}$ ;  
 $f = 1990\text{ MHz}$

**Fig 7. GSM EDGE rms EVM and peak EVM as functions of average load power; typical values**

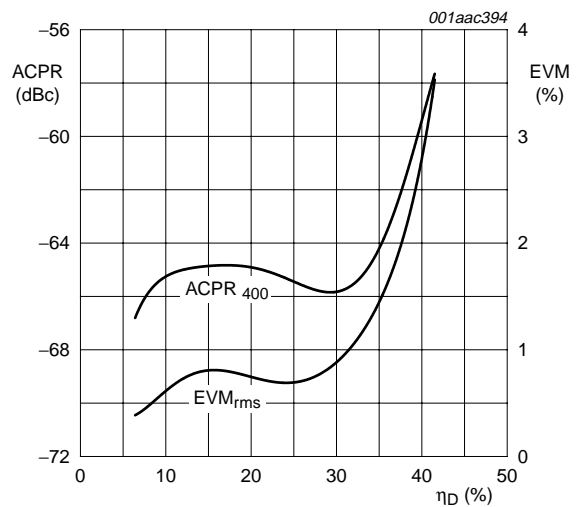

$V_{DS} = 28\text{ V}$ ;  $I_{Dq} = 650\text{ mA}$ ;  $T_{case} = 25\text{ }^\circ\text{C}$ ;  
 $f = 1990\text{ MHz}$

**Fig 8. GSM EDGE ACPR at 400 kHz and rms EVM as functions of drain efficiency; typical values**

**8. Test information**

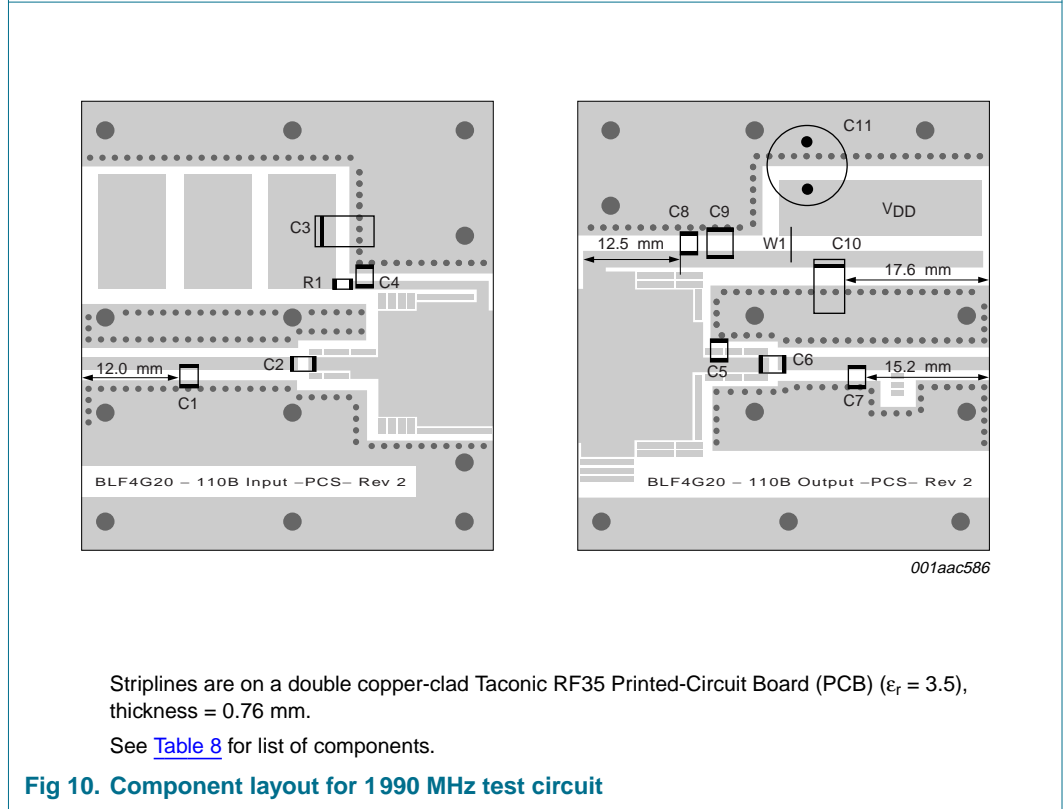
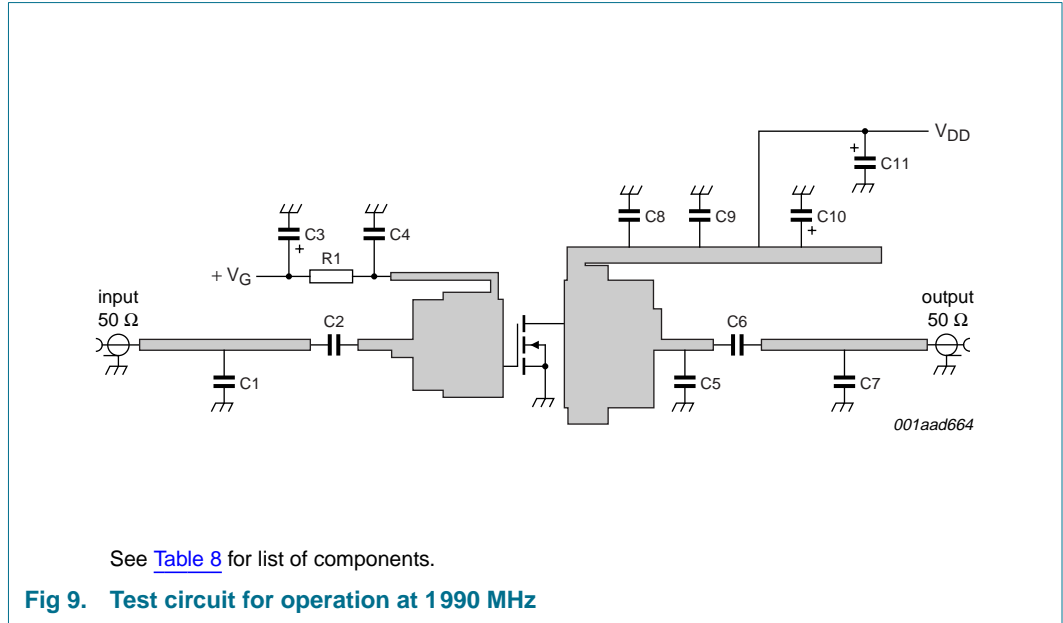

Table 8: List of components (see [Figure 9](#) and [10](#)).

Component	Description	Value	Dimensions	Catalogue number
C1	multilayer ceramic chip capacitor	[1] 0.1 pF		
C2, C4, C8	multilayer ceramic chip capacitor	[1] 11 pF		
C3, C10	multilayer ceramic chip capacitor	10 $\mu$ F		
C5	multilayer ceramic chip capacitor	[1] 0.5 pF		
C6	multilayer ceramic chip capacitor	[1] 8.2 pF		
C7	multilayer ceramic chip capacitor	[1] 0.2 pF		
C9	multilayer ceramic chip capacitor	[1] 1 $\mu$ F		1812X7R105KL2AB
C11	Philips electrolytic capacitor	220 $\mu$ F; 35 V		
R1	Philips chip resistor	5.6 $\Omega$	0603	
W1	hand made wire		5 mm	

[1] American Technical Ceramics type 100B or capacitor of same quality.



**9. Package outline**

Flanged LDMOST ceramic package; 2 mounting holes; 2 leads

SOT502A

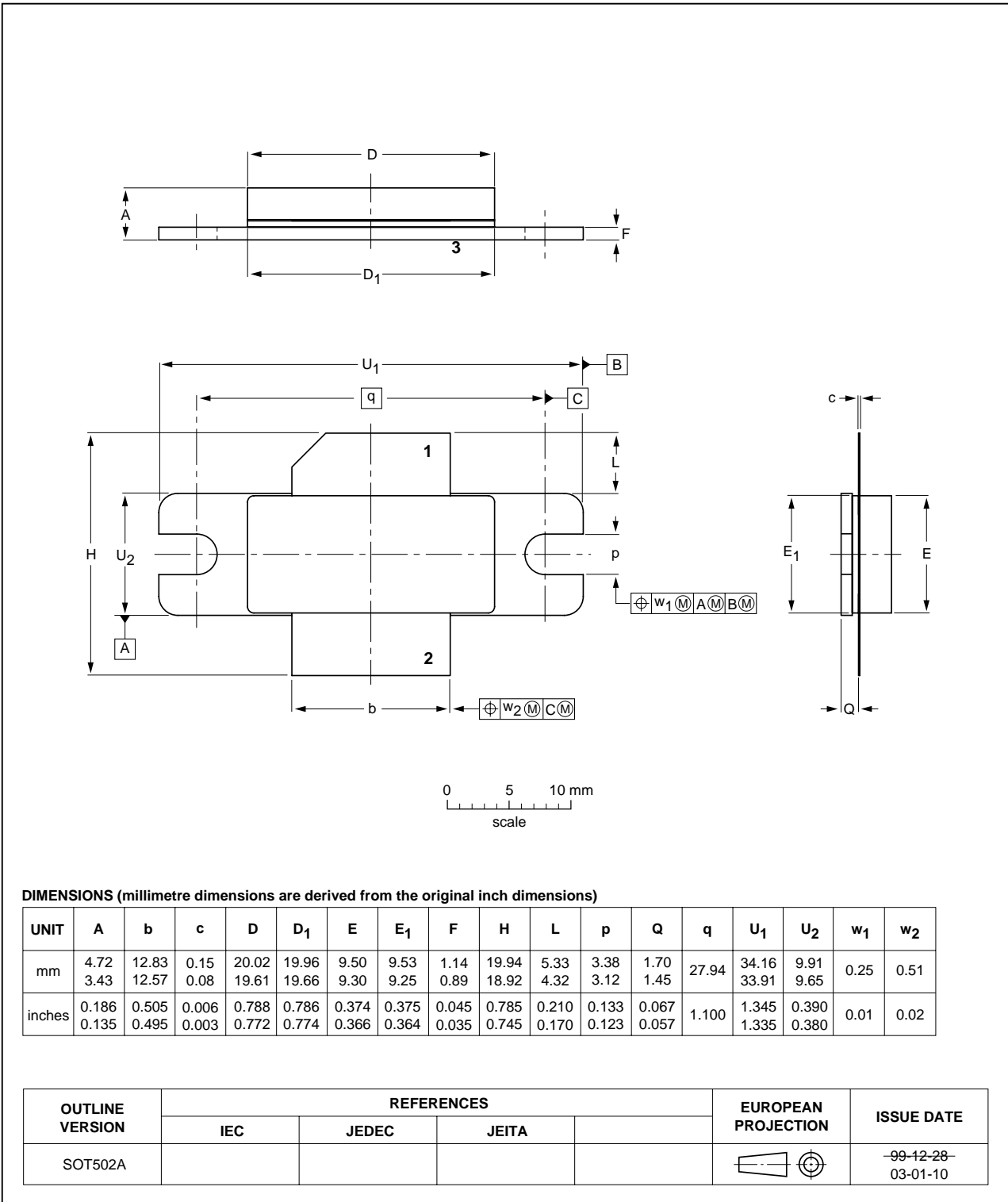

Fig 11. Package outline SOT502A

Earless flanged LDMOST ceramic package; 2 leads

SOT502B

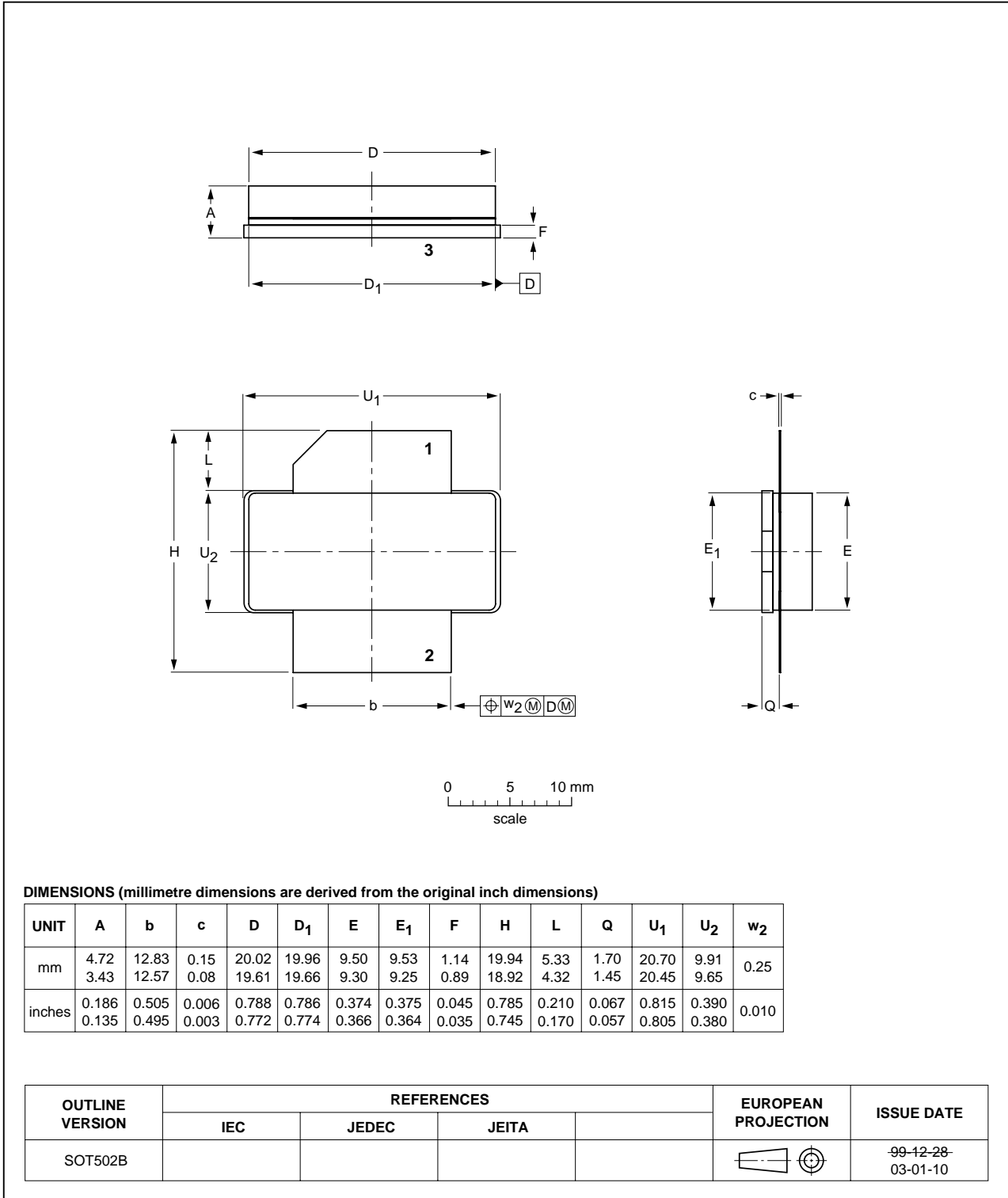

Fig 12. Package outline SOT502B

## 10. Abbreviations

Table 9: List of abbreviations

Abbreviation	Description
ACPR	Adjacent Channel Power Ratio
CDMA	Code Division Multiple Access
CW	Continuous Wave
EDGE	Enhanced Data rates for GSM Evolution
EVM	Error Vector Magnitude
GSM	Global System for Mobile communications
$I_{Dq}$	quiescent drain current
LDMOS	Laterally Diffused Metal Oxide Semiconductor
PEP	Peak Envelope Power
RF	Radio Frequency
VSWR	Voltage Standing Wave Ratio

## 11. Revision history

**Table 10: Revision history**

Document ID	Release date	Data sheet status	Change notice	Doc. number	Supersedes
BLF4G20-110B_4G20S-110B_1	20060123	Product data sheet	-	6397 750 14611	-

## 12. Data sheet status

Level	Data sheet status <sup>[1]</sup>	Product status <sup>[2] [3]</sup>	Definition
I	Objective data	Development	This data sheet contains data from the objective specification for product development. Philips Semiconductors reserves the right to change the specification in any manner without notice.
II	Preliminary data	Qualification	This data sheet contains data from the preliminary specification. Supplementary data will be published at a later date. Philips Semiconductors reserves the right to change the specification without notice, in order to improve the design and supply the best possible product.
III	Product data	Production	This data sheet contains data from the product specification. Philips Semiconductors reserves the right to make changes at any time in order to improve the design, manufacturing and supply. Relevant changes will be communicated via a Customer Product/Process Change Notification (CPCN).

[1] Please consult the most recently issued data sheet before initiating or completing a design.

[2] The product status of the device(s) described in this data sheet may have changed since this data sheet was published. The latest information is available on the Internet at URL <http://www.semiconductors.philips.com>.

[3] For data sheets describing multiple type numbers, the highest-level product status determines the data sheet status.

## 13. Definitions

**Short-form specification** — The data in a short-form specification is extracted from a full data sheet with the same type number and title. For detailed information see the relevant data sheet or data handbook.

**Limiting values definition** — Limiting values given are in accordance with the Absolute Maximum Rating System (IEC 60134). Stress above one or more of the limiting values may cause permanent damage to the device. These are stress ratings only and operation of the device at these or at any other conditions above those given in the Characteristics sections of the specification is not implied. Exposure to limiting values for extended periods may affect device reliability.

**Application information** — Applications that are described herein for any of these products are for illustrative purposes only. Philips Semiconductors makes no representation or warranty that such applications will be suitable for the specified use without further testing or modification.

## 14. Disclaimers

**Life support** — These products are not designed for use in life support appliances, devices, or systems where malfunction of these products can reasonably be expected to result in personal injury. Philips Semiconductors

## 16. Contact information

For additional information, please visit: <http://www.semiconductors.philips.com>

For sales office addresses, send an email to: [sales.addresses@www.semiconductors.philips.com](mailto:sales.addresses@www.semiconductors.philips.com)

customers using or selling these products for use in such applications do so at their own risk and agree to fully indemnify Philips Semiconductors for any damages resulting from such application.

**Right to make changes** — Philips Semiconductors reserves the right to make changes in the products - including circuits, standard cells, and/or software - described or contained herein in order to improve design and/or performance. When the product is in full production (status 'Production'), relevant changes will be communicated via a Customer Product/Process Change Notification (CPCN). Philips Semiconductors assumes no responsibility or liability for the use of any of these products, conveys no license or title under any patent, copyright, or mask work right to these products, and makes no representations or warranties that these products are free from patent, copyright, or mask work right infringement, unless otherwise specified.

## 15. Trademarks

**Notice** — All referenced brands, product names, service names and trademarks are the property of their respective owners.

## 17. Contents

---

<b>1</b>	<b>Product profile</b> .....	<b>1</b>
1.1	General description .....	1
1.2	Features .....	1
1.3	Applications .....	2
<b>2</b>	<b>Pinning information</b> .....	<b>2</b>
<b>3</b>	<b>Ordering information</b> .....	<b>2</b>
<b>4</b>	<b>Limiting values</b> .....	<b>3</b>
<b>5</b>	<b>Thermal characteristics</b> .....	<b>3</b>
<b>6</b>	<b>Characteristics</b> .....	<b>3</b>
<b>7</b>	<b>Application information</b> .....	<b>4</b>
7.1	Ruggedness in class-AB operation .....	4
<b>8</b>	<b>Test information</b> .....	<b>7</b>
<b>9</b>	<b>Package outline</b> .....	<b>9</b>
<b>10</b>	<b>Abbreviations</b> .....	<b>11</b>
<b>11</b>	<b>Revision history</b> .....	<b>12</b>
<b>12</b>	<b>Data sheet status</b> .....	<b>13</b>
<b>13</b>	<b>Definitions</b> .....	<b>13</b>
<b>14</b>	<b>Disclaimers</b> .....	<b>13</b>
<b>15</b>	<b>Trademarks</b> .....	<b>13</b>
<b>16</b>	<b>Contact information</b> .....	<b>13</b>



© Koninklijke Philips Electronics N.V. 2006

All rights are reserved. Reproduction in whole or in part is prohibited without the prior written consent of the copyright owner. The information presented in this document does not form part of any quotation or contract, is believed to be accurate and reliable and may be changed without notice. No liability will be accepted by the publisher for any consequence of its use. Publication thereof does not convey nor imply any license under patent- or other industrial or intellectual property rights.

Date of release: 23 January 2006  
Document number: 9397 750 14611

Published in The Netherlands