

# BLF642

## Broadband power LDMOS transistor

Rev. 2 — 22 July 2011

Product data sheet

## 1. Product profile

### 1.1 General description

A 35 W LDMOS RF power transistor for broadcast transmitter and industrial applications. The transistor is suitable for the frequency range HF to 1400 MHz. The excellent ruggedness and broadband performance of this device makes it ideal for digital applications.

**Table 1. Typical performance**

*RF performance at  $T_h = 25\text{ °C}$  in a common source test circuit.*

Mode of operation	f (MHz)	V <sub>DS</sub> (V)	P <sub>L</sub> (W)	G <sub>p</sub> (dB)	η <sub>D</sub> (%)	IMD (dBc)
CW, class-AB	1300	32	35	19	63	-
2-tone, class-AB	1300	32	17.5	19	48	-28

### 1.2 Features and benefits

- CW performance at 1300 MHz, a drain-source voltage V<sub>DS</sub> of 32 V and a quiescent drain current I<sub>Dq</sub> = 0.2 A :
  - ◆ Average output power = 35 W
  - ◆ Power gain = 19 dB
  - ◆ Drain efficiency = 63 %
- 2-tone performance at 1300 MHz, a drain-source voltage V<sub>DS</sub> of 32 V and a quiescent drain current I<sub>Dq</sub> = 0.2 A :
  - ◆ Average output power = 17.5 W
  - ◆ Power gain = 19 dB
  - ◆ Drain efficiency = 48 %
  - ◆ Intermodulation distortion = -28 dBc
- Integrated ESD protection
- Excellent ruggedness
- High power gain
- High efficiency
- Excellent reliability
- Easy power control
- Compliant to Directive 2002/95/EC, regarding Restriction of Hazardous Substances (RoHS)



### 1.3 Applications

- Communication transmitter applications in the HF to 1400 MHz frequency range
- Industrial applications in the HF to 1400 MHz frequency range

## 2. Pinning information

Table 2. Pinning

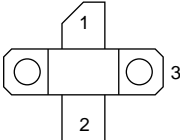
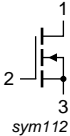
Pin	Description	Simplified outline	Graphic symbol
1	drain		 sym112
2	gate		
3	source		

[1] Connected to flange

## 3. Ordering information

Table 3. Ordering information

Type number	Package		
	Name	Description	Version
BLF642	-	flanged LDMOST ceramic package; 2 mounting holes; 2 leads	SOT467C

## 4. Limiting values

Table 4. Limiting values

In accordance with the Absolute Maximum Rating System (IEC 60134).

Symbol	Parameter	Conditions	Min	Max	Unit
$V_{DS}$	drain-source voltage		-	65	V
$V_{GS}$	gate-source voltage		-0.5	+11	V
$T_{stg}$	storage temperature		-65	+150	°C
$T_j$	junction temperature		-	200	°C

## 5. Thermal characteristics

Table 5. Thermal characteristics

Symbol	Parameter	Conditions	Typ	Unit
$R_{th(j-c)}$	thermal resistance from junction to case	$T_{case} = 80\text{ °C}$ ; $P_L = 35\text{ W}$	[1] 1.6	K/W

[1]  $R_{th(j-c)}$  is measured under RF conditions.

## 6. Characteristics

**Table 6. Characteristics per section**

$T_j = 25\text{ °C}$ ; unless otherwise specified.

Symbol	Parameter	Conditions	Min	Typ	Max	Unit
$V_{(BR)DSS}$	drain-source breakdown voltage	$V_{GS} = 0\text{ V}$ ; $I_D = 0.5\text{ mA}$	65	-	-	V
$V_{GS(th)}$	gate-source threshold voltage	$V_{DS} = 32\text{ V}$ ; $I_D = 50\text{ mA}$	1.4	1.9	2.4	V
$V_{GSq}$	gate-source quiescent voltage	$V_{DS} = 32\text{ V}$ ; $I_{Dq} = 250\text{ mA}$	1.5	2.0	2.5	V
$I_{DSS}$	drain leakage current	$V_{GS} = 0\text{ V}$ ; $V_{DS} = 32\text{ V}$	-	-	1.4	$\mu\text{A}$
$I_{DSX}$	drain cut-off current	$V_{GS} = V_{GS(th)} + 3.75\text{ V}$ ; $V_{DS} = 10\text{ V}$	8.0	9.0	-	A
$I_{GSS}$	gate leakage current	$V_{GS} = \pm 10\text{ V}$ ; $V_{DS} = 0\text{ V}$	-	-	50	nA
$g_{fs}$	forward transconductance	$V_{DS} = 10\text{ V}$ ; $I_D = 2.5\text{ A}$	-	3.3	-	S
$R_{DS(on)}$	drain-source on-state resistance	$V_{GS} = V_{GS(th)} + 3.75\text{ V}$ ; $I_D = 1.75\text{ A}$	-	300	-	$\text{m}\Omega$
$C_{iss}$	input capacitance	$V_{GS} = 0\text{ V}$ ; $V_{DS} = 32\text{ V}$ ; $f = 1\text{ MHz}$	-	39	-	pF
$C_{oss}$	output capacitance	$V_{GS} = 0\text{ V}$ ; $V_{DS} = 32\text{ V}$ ; $f = 1\text{ MHz}$	-	15	-	pF
$C_{rs}$	feedback capacitance	$V_{GS} = 0\text{ V}$ ; $V_{DS} = 32\text{ V}$ ; $f = 1\text{ MHz}$	-	0.84	-	pF

## 7. Application information

**Table 7. RF performance in a common-source class-AB circuit**

$T_h = 25\text{ °C}$ ;  $I_{Dq} = 0.2\text{ A}$ .

Mode of operation	f (MHz)	$V_{DS}$ (V)	$P_L$ (W)	$G_p$ (dB)	$\eta_D$ (%)
CW, class-AB	1300	32	35	> 18	> 59

### 7.1 Ruggedness in class-AB operation

The BLF642 is capable of withstanding a load mismatch corresponding to VSWR = 10 : 1 through all phases under the following conditions:  $V_{DS} = 32\text{ V}$ ;  $f = 1300\text{ MHz}$  at rated load power.

## 8. Test information

### 8.1 RF performance

The following figures are measured in a class-AB production test circuit.

#### 8.1.1 1-Tone CW

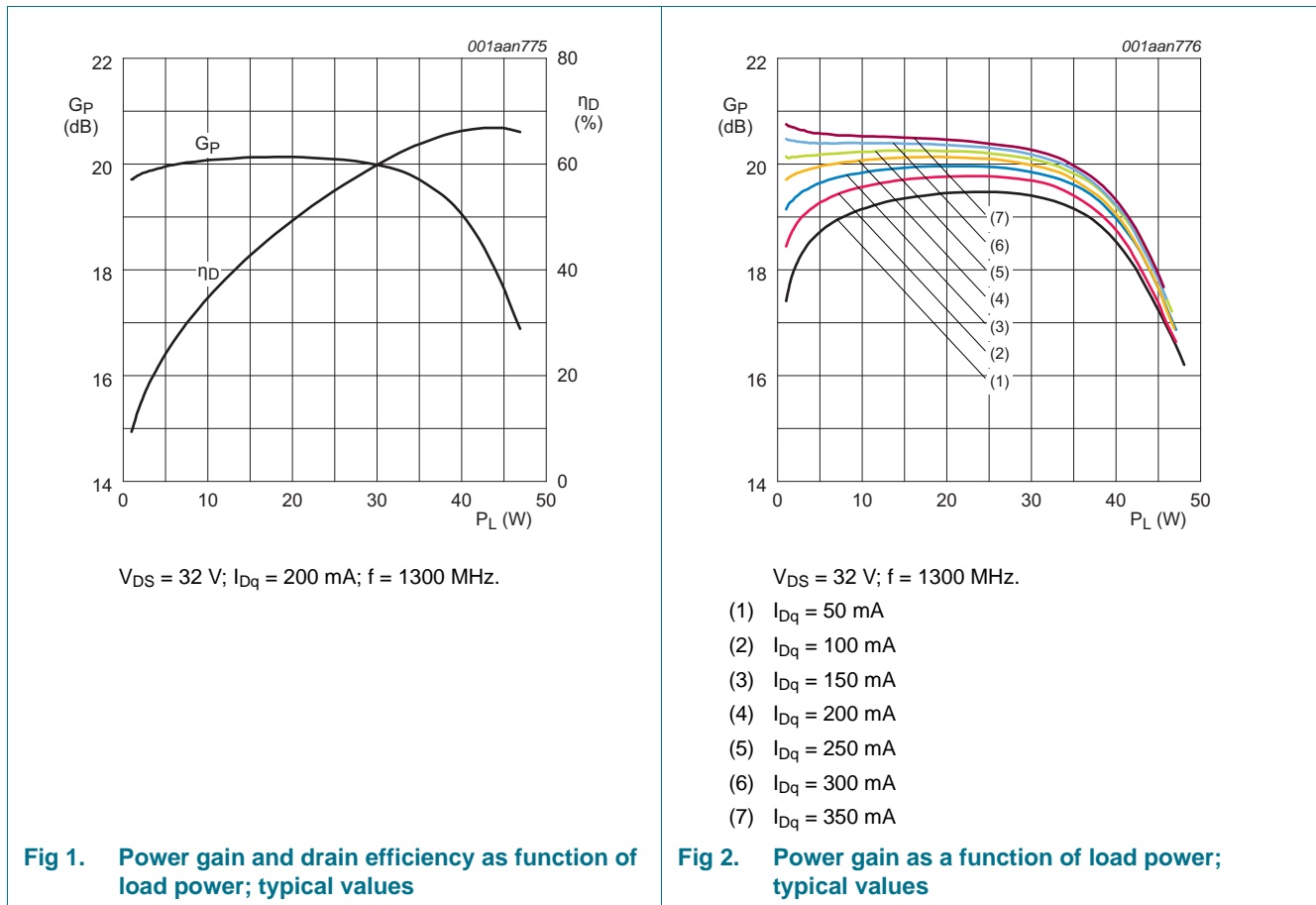

8.1.2 2-Tone CW

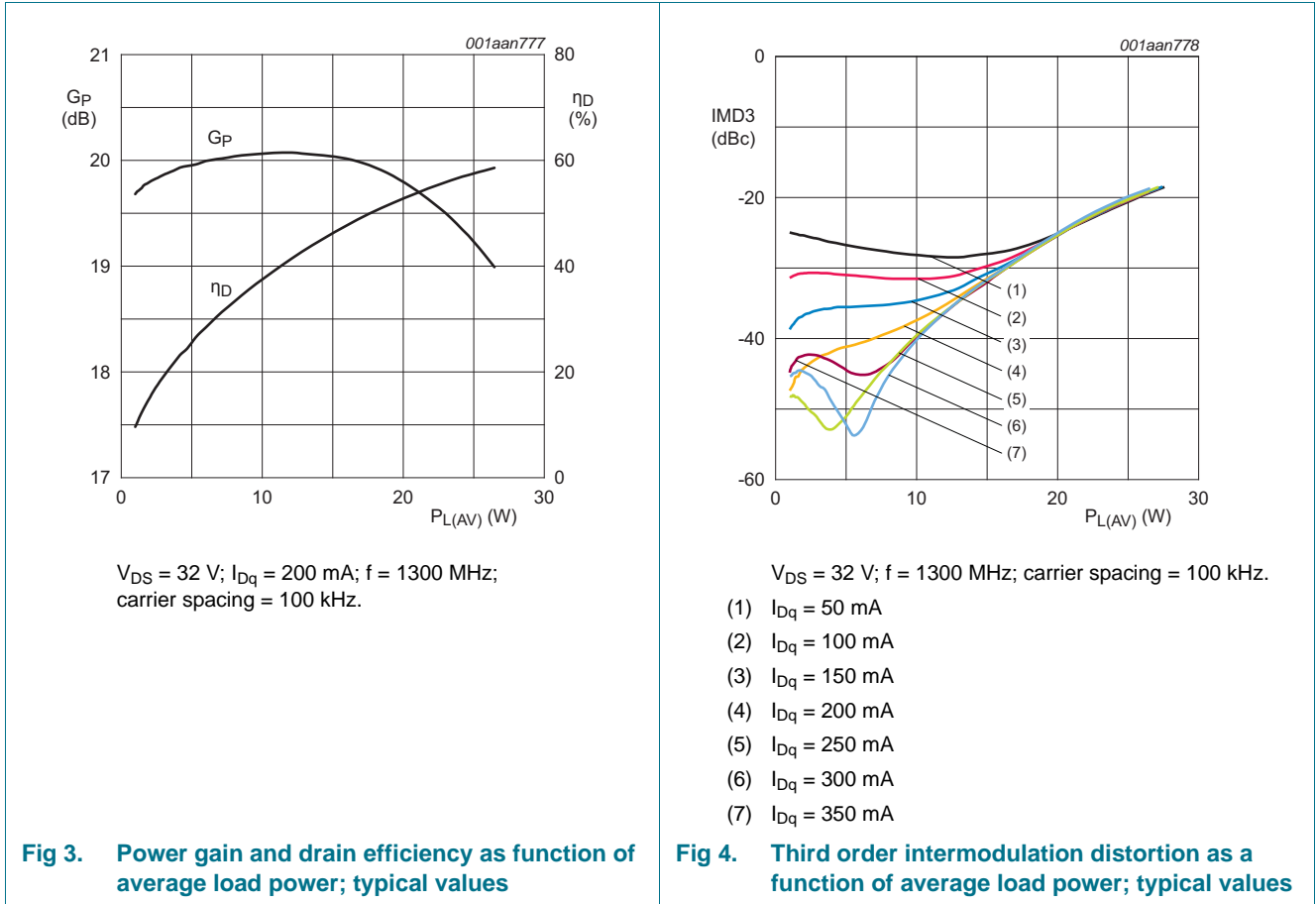

8.1.3 Pulsed CW

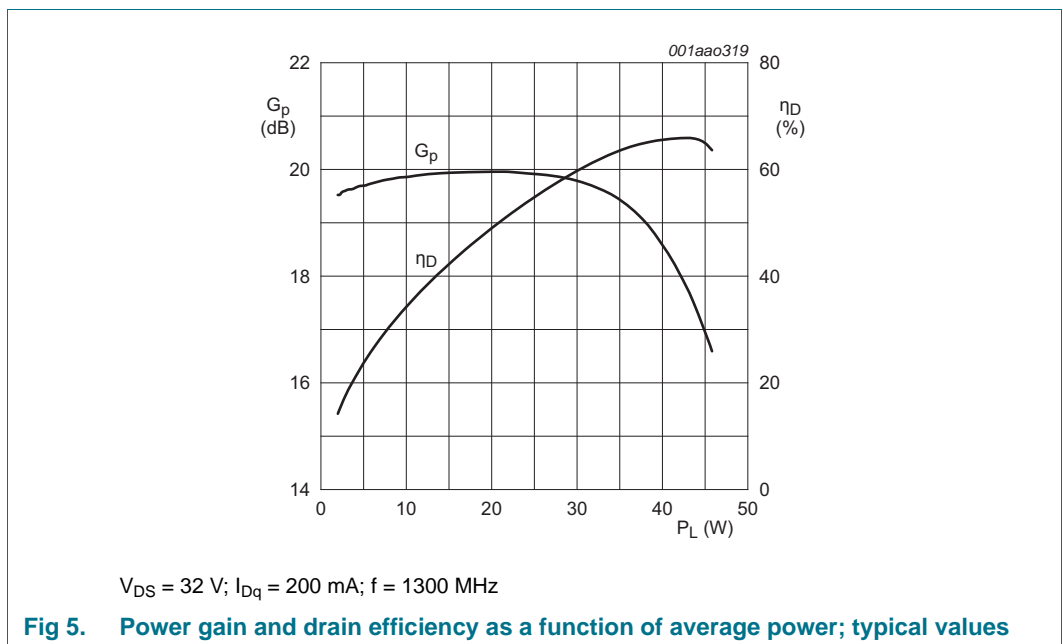

8.1.4 DVB-T

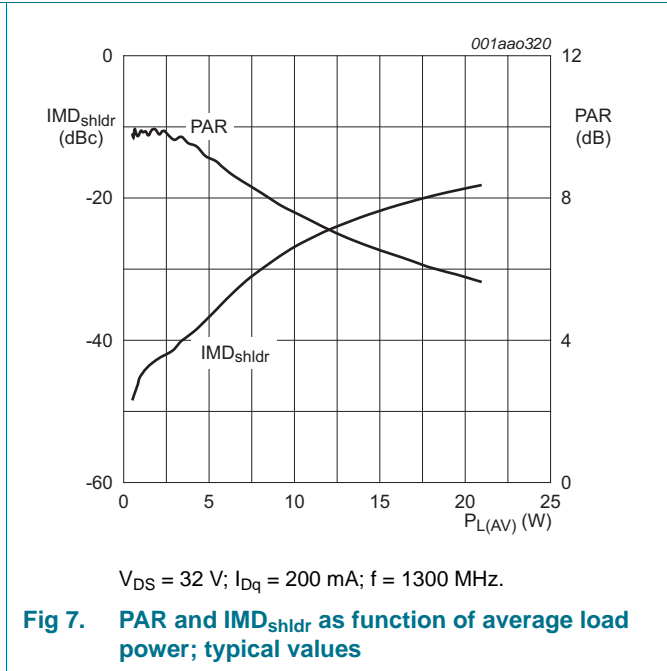
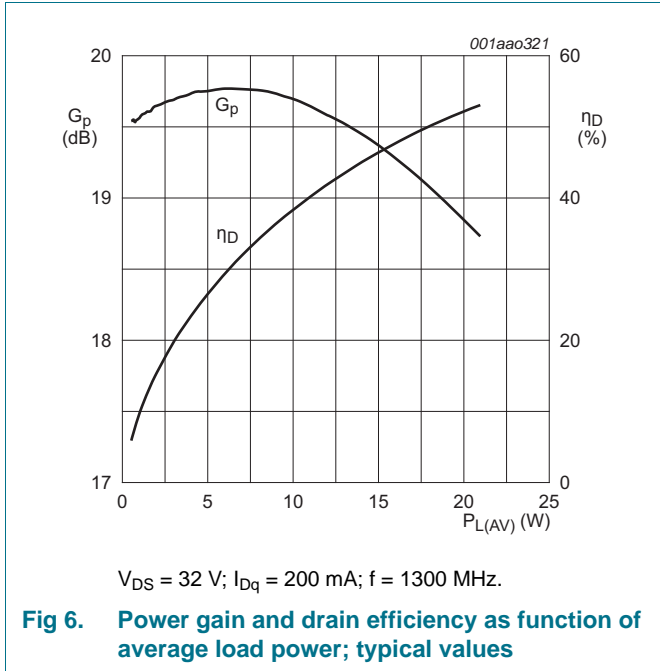

8.2 Test circuit

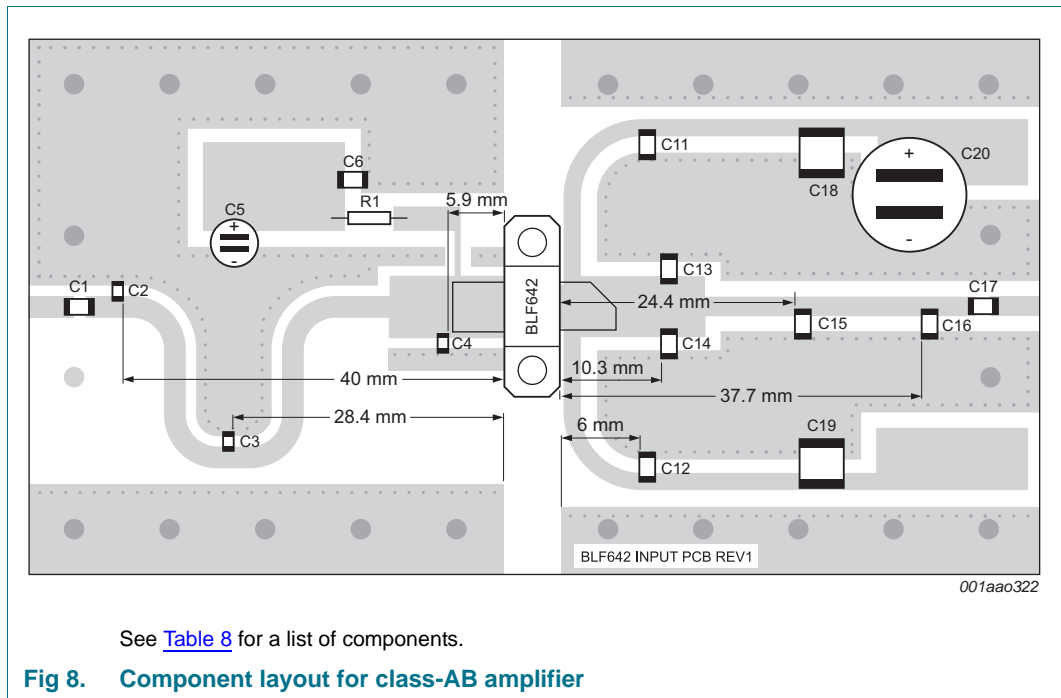

**Table 8. List of components**

For production test circuit, see [Figure 8](#).

Printed-Circuit Board (PCB): Rogers 5880;  $\epsilon_r = 2.2$ ; height = 0.762 mm; Copper (top/bottom metallization); thickness copper plating = 35  $\mu\text{m}$ .

Component	Description	Value	Remarks
C1	multilayer ceramic chip capacitor	22 pF	[1]
C2	multilayer ceramic chip capacitor	5.1 pF	[2]
C3	multilayer ceramic chip capacitor	4.3 pF	[2]
C4	multilayer ceramic chip capacitor	10 pF	[2]
C5	electrolytic chip capacitor	10 $\mu\text{F}$ ; 50 V	
C6	multilayer ceramic chip capacitor	22 nF	
C11, C12	multilayer ceramic chip capacitor	22 pF	[1]
C13, C14	multilayer ceramic chip capacitor	6.2 pF	[1]
C15	multilayer ceramic chip capacitor	4.3 pF	[1]
C16	multilayer ceramic chip capacitor	1.2 pF	[1]
C17	multilayer ceramic chip capacitor	22 pF	[1]
C18, C19	multilayer ceramic chip capacitor	10 $\mu\text{F}$	[3]
C20	electrolytic capacitor	470 $\mu\text{F}$ ; 63 V	
R1	wire resistor	100 $\Omega$	

[1] American Technical Ceramics type 100B or capacitor of same quality.

[2] American Technical Ceramics type 100A or capacitor of same quality.

[3] TDK C570X7R1H106KT000N or capacitor of same quality.

9. Package outline

Flanged LDMOST ceramic package; 2 mounting holes; 2 leads

SOT467C

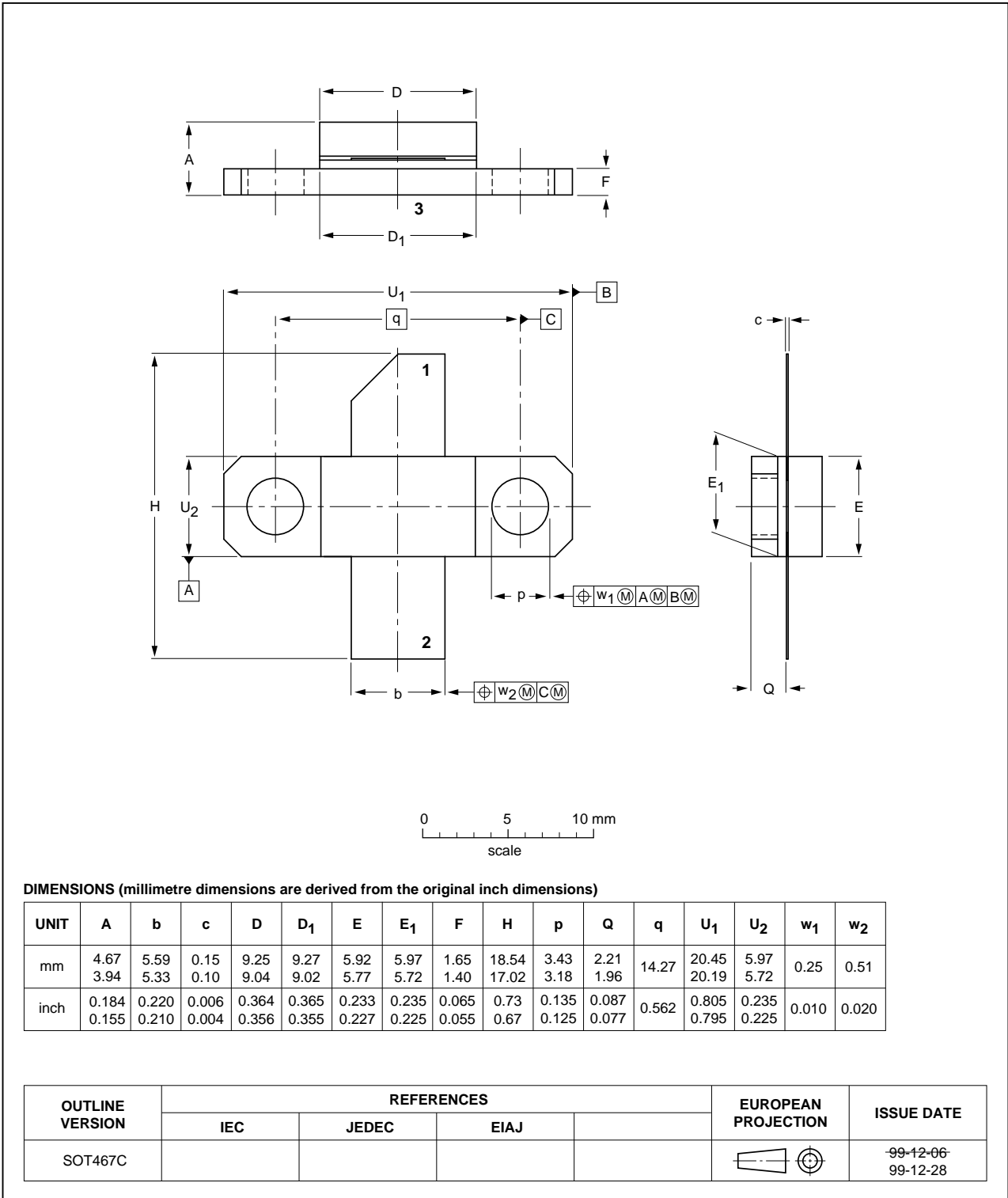

Fig 9. Package outline SOT467C



## 10. Abbreviations

Table 9. Abbreviations

Acronym	Description
CW	Continuous Waveform
DVB-T	Digital Video Broadcast - Terrestrial
ESD	ElectroStatic Discharge
HF	High Frequency
LDMOS	Laterally Diffused Metal Oxide Semiconductor
LDMOST	Laterally Diffused Metal-Oxide Semiconductor Transistor
PAR	Peak-to-Average power Ratio
RF	Radio Frequency
VSWR	Voltage Standing-Wave Ratio

## 11. Revision history

Table 10. Revision history

Document ID	Release date	Data sheet status	Change notice	Supersedes
BLF642 v.2	20110722	Product data sheet	-	BLF642 v.1
Modifications:	<ul style="list-style-type: none"> <li>The status of this data sheet has been changed to Product data sheet</li> <li><a href="#">Table 5 on page 2</a>: The value for <math>R_{th(j-c)}</math> has been changed.</li> <li><a href="#">Table 6 on page 3</a>: Some values have been changed.</li> <li><a href="#">Section 8.1.3 on page 5</a>: Section has been added.</li> <li><a href="#">Section 8.1.4 on page 6</a>: Section has been added.</li> <li><a href="#">Section 8.2 on page 6</a>: Section has been added.</li> </ul>			
BLF642 v.1	20110308	Objective data sheet	-	-

## 12. Legal information

### 12.1 Data sheet status

Document status <sup>[1][2]</sup>	Product status <sup>[3]</sup>	Definition
Objective [short] data sheet	Development	This document contains data from the objective specification for product development.
Preliminary [short] data sheet	Qualification	This document contains data from the preliminary specification.
Product [short] data sheet	Production	This document contains the product specification.

[1] Please consult the most recently issued document before initiating or completing a design.

[2] The term 'short data sheet' is explained in section "Definitions".

[3] The product status of device(s) described in this document may have changed since this document was published and may differ in case of multiple devices. The latest product status information is available on the Internet at URL <http://www.nxp.com>.

### 12.2 Definitions

**Draft** — The document is a draft version only. The content is still under internal review and subject to formal approval, which may result in modifications or additions. NXP Semiconductors does not give any representations or warranties as to the accuracy or completeness of information included herein and shall have no liability for the consequences of use of such information.

**Short data sheet** — A short data sheet is an extract from a full data sheet with the same product type number(s) and title. A short data sheet is intended for quick reference only and should not be relied upon to contain detailed and full information. For detailed and full information see the relevant full data sheet, which is available on request via the local NXP Semiconductors sales office. In case of any inconsistency or conflict with the short data sheet, the full data sheet shall prevail.

**Product specification** — The information and data provided in a Product data sheet shall define the specification of the product as agreed between NXP Semiconductors and its customer, unless NXP Semiconductors and customer have explicitly agreed otherwise in writing. In no event however, shall an agreement be valid in which the NXP Semiconductors product is deemed to offer functions and qualities beyond those described in the Product data sheet.

### 12.3 Disclaimers

**Limited warranty and liability** — Information in this document is believed to be accurate and reliable. However, NXP Semiconductors does not give any representations or warranties, expressed or implied, as to the accuracy or completeness of such information and shall have no liability for the consequences of use of such information.

In no event shall NXP Semiconductors be liable for any indirect, incidental, punitive, special or consequential damages (including - without limitation - lost profits, lost savings, business interruption, costs related to the removal or replacement of any products or rework charges) whether or not such damages are based on tort (including negligence), warranty, breach of contract or any other legal theory.

Notwithstanding any damages that customer might incur for any reason whatsoever, NXP Semiconductors' aggregate and cumulative liability towards customer for the products described herein shall be limited in accordance with the *Terms and conditions of commercial sale* of NXP Semiconductors.

**Right to make changes** — NXP Semiconductors reserves the right to make changes to information published in this document, including without limitation specifications and product descriptions, at any time and without notice. This document supersedes and replaces all information supplied prior to the publication hereof.

**Suitability for use** — NXP Semiconductors products are not designed, authorized or warranted to be suitable for use in life support, life-critical or safety-critical systems or equipment, nor in applications where failure or

malfunction of an NXP Semiconductors product can reasonably be expected to result in personal injury, death or severe property or environmental damage. NXP Semiconductors accepts no liability for inclusion and/or use of NXP Semiconductors products in such equipment or applications and therefore such inclusion and/or use is at the customer's own risk.

**Applications** — Applications that are described herein for any of these products are for illustrative purposes only. NXP Semiconductors makes no representation or warranty that such applications will be suitable for the specified use without further testing or modification.

Customers are responsible for the design and operation of their applications and products using NXP Semiconductors products, and NXP Semiconductors accepts no liability for any assistance with applications or customer product design. It is customer's sole responsibility to determine whether the NXP Semiconductors product is suitable and fit for the customer's applications and products planned, as well as for the planned application and use of customer's third party customer(s). Customers should provide appropriate design and operating safeguards to minimize the risks associated with their applications and products.

NXP Semiconductors does not accept any liability related to any default, damage, costs or problem which is based on any weakness or default in the customer's applications or products, or the application or use by customer's third party customer(s). Customer is responsible for doing all necessary testing for the customer's applications and products using NXP Semiconductors products in order to avoid a default of the applications and the products or of the application or use by customer's third party customer(s). NXP does not accept any liability in this respect.

**Limiting values** — Stress above one or more limiting values (as defined in the Absolute Maximum Ratings System of IEC 60134) will cause permanent damage to the device. Limiting values are stress ratings only and (proper) operation of the device at these or any other conditions above those given in the Recommended operating conditions section (if present) or the Characteristics sections of this document is not warranted. Constant or repeated exposure to limiting values will permanently and irreversibly affect the quality and reliability of the device.

**Terms and conditions of commercial sale** — NXP Semiconductors products are sold subject to the general terms and conditions of commercial sale, as published at <http://www.nxp.com/profile/terms>, unless otherwise agreed in a valid written individual agreement. In case an individual agreement is concluded only the terms and conditions of the respective agreement shall apply. NXP Semiconductors hereby expressly objects to applying the customer's general terms and conditions with regard to the purchase of NXP Semiconductors products by customer.

**No offer to sell or license** — Nothing in this document may be interpreted or construed as an offer to sell products that is open for acceptance or the grant, conveyance or implication of any license under any copyrights, patents or other industrial or intellectual property rights.

**Export control** — This document as well as the item(s) described herein may be subject to export control regulations. Export might require a prior authorization from national authorities.

**Non-automotive qualified products** — Unless this data sheet expressly states that this specific NXP Semiconductors product is automotive qualified, the product is not suitable for automotive use. It is neither qualified nor tested in accordance with automotive testing or application requirements. NXP Semiconductors accepts no liability for inclusion and/or use of non-automotive qualified products in automotive equipment or applications.

In the event that customer uses the product for design-in and use in automotive applications to automotive specifications and standards, customer (a) shall use the product without NXP Semiconductors' warranty of the product for such automotive applications, use and specifications, and (b) whenever customer uses the product for automotive applications beyond NXP Semiconductors' specifications such use shall be solely at customer's own risk, and (c) customer fully indemnifies NXP Semiconductors for any liability, damages or failed product claims resulting from customer design and use of the product for automotive applications beyond NXP Semiconductors' standard warranty and NXP Semiconductors' product specifications.

## 13. Contact information

For more information, please visit: <http://www.nxp.com>

For sales office addresses, please send an email to: [salesaddresses@nxp.com](mailto:salesaddresses@nxp.com)

## 12.4 Licenses

### ICs with DVB-T or DVB-T2 functionality

Use of this product in any manner that complies with the DVB-T or the DVB-T2 standard may require licenses under applicable patents of the DVB-T respectively the DVB-T2 patent portfolio, which license is available from Sisvel S.p.A., Via Sestriere 100, 10060 None (TO), Italy, and under applicable patents of other parties.

## 12.5 Trademarks

Notice: All referenced brands, product names, service names and trademarks are the property of their respective owners.

## 14. Contents

<b>1</b>	<b>Product profile</b> . . . . .	<b>1</b>
1.1	General description . . . . .	1
1.2	Features and benefits . . . . .	1
1.3	Applications . . . . .	2
<b>2</b>	<b>Pinning information</b> . . . . .	<b>2</b>
<b>3</b>	<b>Ordering information</b> . . . . .	<b>2</b>
<b>4</b>	<b>Limiting values</b> . . . . .	<b>2</b>
<b>5</b>	<b>Thermal characteristics</b> . . . . .	<b>2</b>
<b>6</b>	<b>Characteristics</b> . . . . .	<b>3</b>
<b>7</b>	<b>Application information</b> . . . . .	<b>3</b>
7.1	Ruggedness in class-AB operation . . . . .	3
<b>8</b>	<b>Test information</b> . . . . .	<b>4</b>
8.1	RF performance . . . . .	4
8.1.1	1-Tone CW . . . . .	4
8.1.2	2-Tone CW . . . . .	5
8.1.3	Pulsed CW . . . . .	5
8.1.4	DVB-T . . . . .	6
8.2	Test circuit . . . . .	6
<b>9</b>	<b>Package outline</b> . . . . .	<b>8</b>
<b>10</b>	<b>Abbreviations</b> . . . . .	<b>9</b>
<b>11</b>	<b>Revision history</b> . . . . .	<b>9</b>
<b>12</b>	<b>Legal information</b> . . . . .	<b>10</b>
12.1	Data sheet status . . . . .	10
12.2	Definitions . . . . .	10
12.3	Disclaimers . . . . .	10
12.4	Licenses . . . . .	11
12.5	Trademarks . . . . .	11
<b>13</b>	<b>Contact information</b> . . . . .	<b>11</b>
<b>14</b>	<b>Contents</b> . . . . .	<b>12</b>

Please be aware that important notices concerning this document and the product(s) described herein, have been included in section 'Legal information'.

© NXP B.V. 2011.

All rights reserved.

For more information, please visit: <http://www.nxp.com>

For sales office addresses, please send an email to: [salesaddresses@nxp.com](mailto:salesaddresses@nxp.com)

Date of release: 22 July 2011

Document identifier: BLF642