

# BLP7G22-10

## LDMOS driver transistor

Rev. 2 — 30 May 2013

Product data sheet

## 1. Product profile

### 1.1 General description

10W plastic LDMOS power transistor for base station applications at frequencies from 700 MHz to 2700 MHz.

**Table 1. Application performance (multiple frequencies)**

Typical RF performance at  $T_{case} = 25\text{ °C}$ ;  $I_{DQ} = 110\text{ mA}$ ; in a class-AB application circuit.

Test signal	f (MHz)	$I_{DQ}$ (mA)	$V_{DS}$ (V)	$P_{L(AV)}$ (W)	$G_p$ (dB)	$\eta_D$ (%)	ACPR <sub>5M</sub> (dBc)
Pulsed CW	2700	110	28	2	14.5	26	-
1-carrier W-CDMA	748	110	28	0.7	27.5	13.5	-43 <a href="#">[1]</a>
	748	110	28	2	27.5	25	-40
2-carrier W-CDMA	2140	110	28	0.7	17.4	13	-51
	2140	110	28	2	17.4	25	-40

[1] Test signal: 2-carrier W-CDMA; carrier spacing = 5 MHz; PAR = 8.4 dB at 0.01 % probability on CCDF; RF performance at  $V_{DS} = 28\text{ V}$ ;  $I_{DQ} = 110\text{ mA}$ .

### 1.2 Features and benefits

- High efficiency
- Excellent ruggedness
- Designed for broadband operation
- Excellent thermal stability
- High power gain
- Integrated ESD protection
- Compliant to Directive 2002/95/EC, regarding Restriction of Hazardous Substances (RoHS)

### 1.3 Applications

- CDMA
- W-CDMA
- GSM EDGE
- MC-GSM
- LTE
- WiMAX



## 2. Pinning information

**Table 2. Pinning**

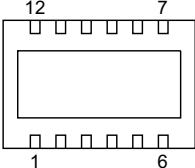
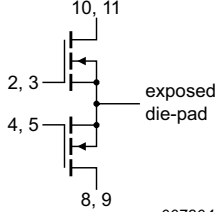
Pin	Description	Simplified outline	Graphic symbol [1]
1, 6, 7, 12	n.c.	 <p>Transparent top view</p>	 <p>aaa-007804</p>
2, 3, 4, 5	gate		
8, 9, 10, 11	drain		
exposed die-pad	source		

[1] To be used in single ended applications only.

## 3. Ordering information

**Table 3. Ordering information**

Type number	Package		
	Name	Description	Version
BLP7G22-10	HVSON12	plastic thermal enhanced very thin small outline package; no leads; 12 terminals; body 6 × 4 × 0.85 mm	SOT1179-2

## 4. Limiting values

**Table 4. Limiting values**

*In accordance with the Absolute Maximum Rating System (IEC 60134).*

Symbol	Parameter	Conditions	Min	Max	Unit
$V_{DS}$	drain-source voltage		-	65	V
$V_{GS}$	gate-source voltage		-0.5	+13	V
$T_{stg}$	storage temperature		-65	+150	°C
$T_j$	junction temperature		-	150	°C

## 5. Recommended operating conditions

See application note AN11198 for more details.

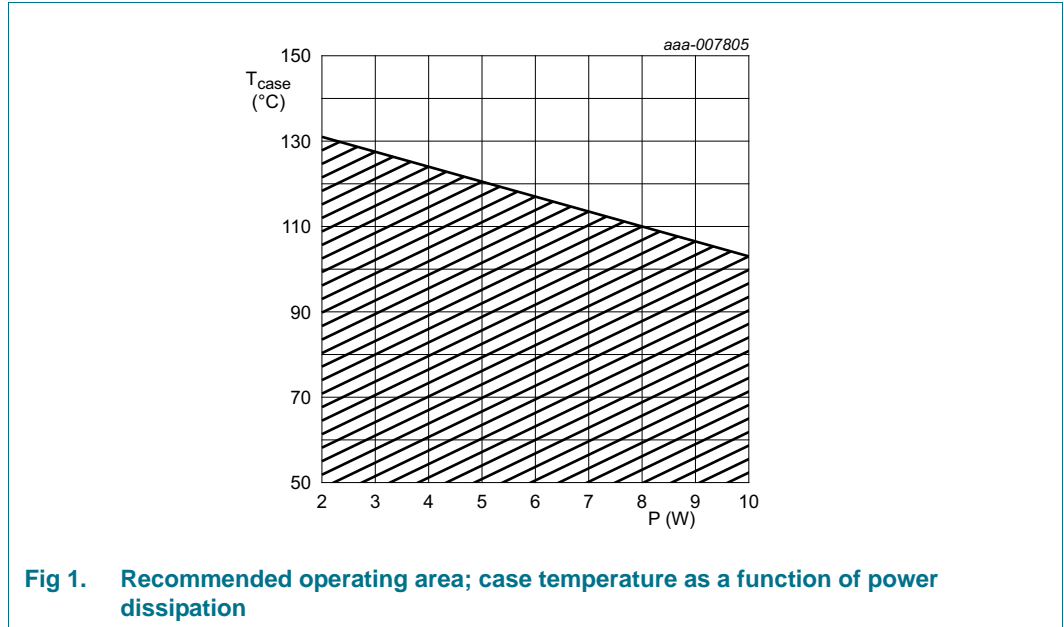

## 6. Thermal characteristics

**Table 5. Thermal characteristics**

Symbol	Parameter	Conditions	Typ	Unit
$R_{th(j-c)}$	thermal resistance from junction to case	$T_{case} = 70\text{ }^{\circ}\text{C}; P_L = 2\text{ W}$	3.2	K/W

## 7. Characteristics

**Table 6. DC characteristics**

$T_j = 25\text{ }^{\circ}\text{C}$ ; unless otherwise specified.

Symbol	Parameter	Conditions	Min	Typ	Max	Unit
$V_{(BR)DSS}$	drain-source breakdown voltage	$V_{GS} = 0\text{ V}; I_D = 0.18\text{ mA}$	65	-	-	V
$V_{GS(th)}$	gate-source threshold voltage	$V_{DS} = 10\text{ V}; I_D = 18\text{ mA}$	1.5	1.9	2.3	V
$I_{DSS}$	drain leakage current	$V_{GS} = 0\text{ V}; V_{DS} = 28\text{ V}$	-1.4	-	+1.4	$\mu\text{A}$
$I_{DSX}$	drain cut-off current	$V_{GS} = V_{GS(th)} + 3.75\text{ V}$	-	3.2	-	A
$I_{GSS}$	gate leakage current	$V_{GS} = 11\text{ V}; V_{DS} = 0\text{ V}$	-	-	140	nA
$g_{fs}$	forward transconductance	$V_{DS} = 10\text{ V}; I_D = 18\text{ mA}$	-	160	-	mS
$R_{DS(on)}$	drain-source on-state resistance	$V_{GS} = V_{GS(th)} + 3.75\text{ V}; V_{DS} = 10\text{ V}; I_D = 630\text{ mA}$	-	1000	-	$\text{m}\Omega$

**Table 7. RF characteristics**

Test signal: 1-tone pulsed;  $t_p = 50 \mu s$ ;  $\delta = 10 \%$ ;  $f = 2140 \text{ MHz}$ ; RF performance at  $V_{DS} = 28 \text{ V}$ ;  $I_{DQ} = 110 \text{ mA}$ ;  $T_{case} = 25 \text{ }^\circ\text{C}$ ; unless otherwise specified, in a production circuit.

Symbol	Parameter	Conditions	Min	Typ	Max	Unit
$G_p$	power gain	$P_{L(AV)} = 2 \text{ W}$	15	16	-	dB
$\eta_D$	drain efficiency	$P_{L(AV)} = 2 \text{ W}$	20	23	-	%
$P_{L(1dB)}$	output power at 1 dB gain compression		11	-	-	W
$RL_{in}$	input return loss	$P_{L(AV)} = 2 \text{ W}$	-	-16	-12	dB

## 8. Application information

### 8.1 Frequency band 2110 MHz to 2170 MHz

#### 8.1.1 Application circuit

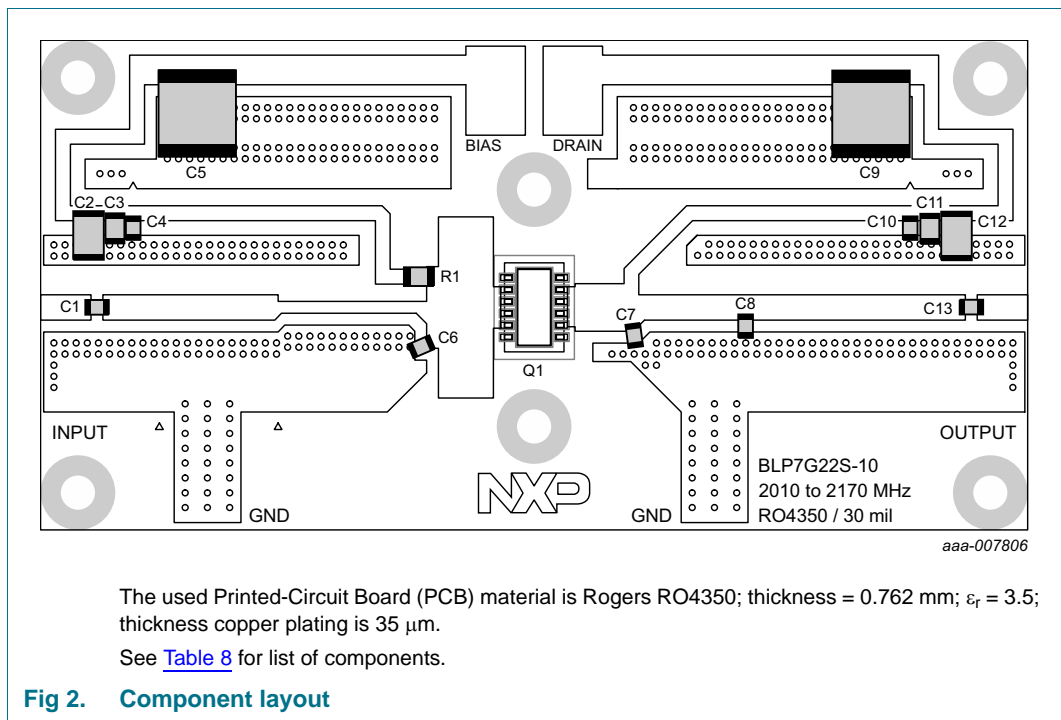

**Fig 2. Component layout**

**Table 8. List of components**

See [Figure 2](#) for component layout.

The used Printed-Circuit Board (PCB) material is Rogers RO4350; thickness = 0.762 mm;  $\epsilon_r = 3.5$ ; thickness copper plating is 35  $\mu m$ .

Component	Description	Value	Remarks
C1, C4, C10, C13	multilayer ceramic chip capacitor	22 pF	[1]
C2, C12	multilayer ceramic chip capacitor	1 $\mu F$	[2]
C3, C11	multilayer ceramic chip capacitor	100 nF	[3]
C5, C9	multilayer ceramic chip capacitor	10 $\mu F$ ; 50 V	[4]
C6	multilayer ceramic chip capacitor	2.8 pF	[1]

**Table 8. List of components ...continued**

See [Figure 2](#) for component layout.

The used Printed-Circuit Board (PCB) material is Rogers RO4350; thickness = 0.762 mm;  $\epsilon_r = 3.5$ ; thickness copper plating is 35  $\mu\text{m}$ .

Component	Description	Value	Remarks
C7	multilayer ceramic chip capacitor	3.9 pF	[1]
C8	multilayer ceramic chip capacitor	1.7 pF	[1]
R1	chip resistor	10 $\Omega$	SMD 0805; 1 % tolerance

[1] American Technical Ceramics type 100A or capacitor of same quality.

[2] Murata GRM31MR71H105KA88L or capacitor of same quality.

[3] Murata GRM21BR71H104KA01L or capacitor of same quality.

[4] Murata GRM32ER71H106KA88L or capacitor of same quality.

### 8.1.2 Graphs

#### 8.1.2.1 Pulsed CW

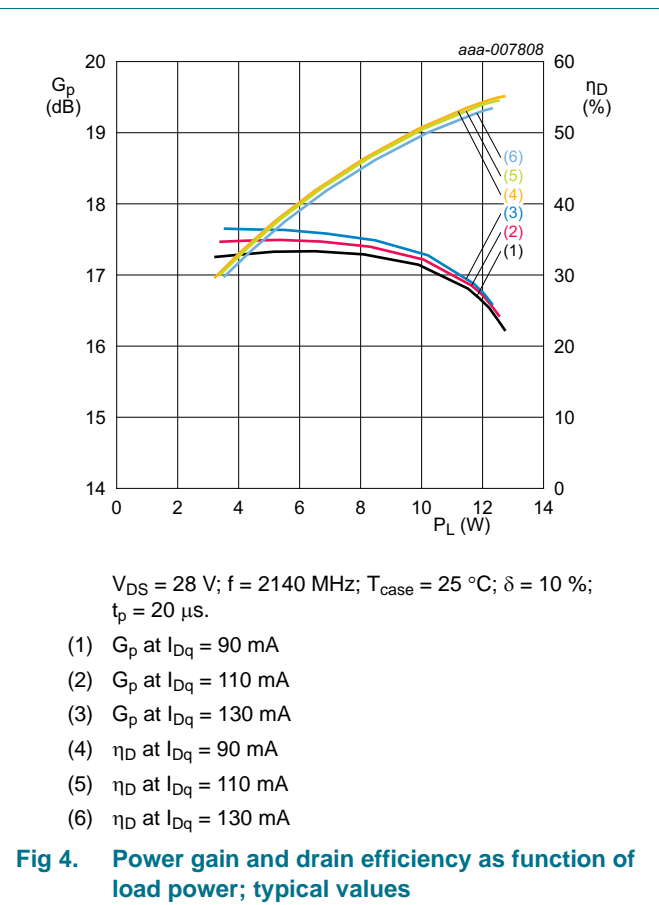
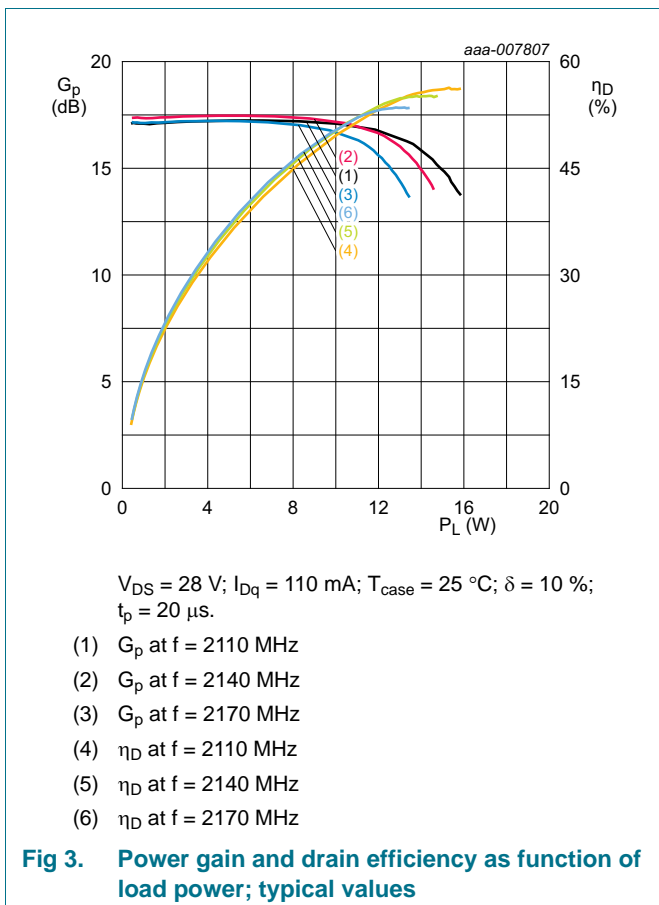

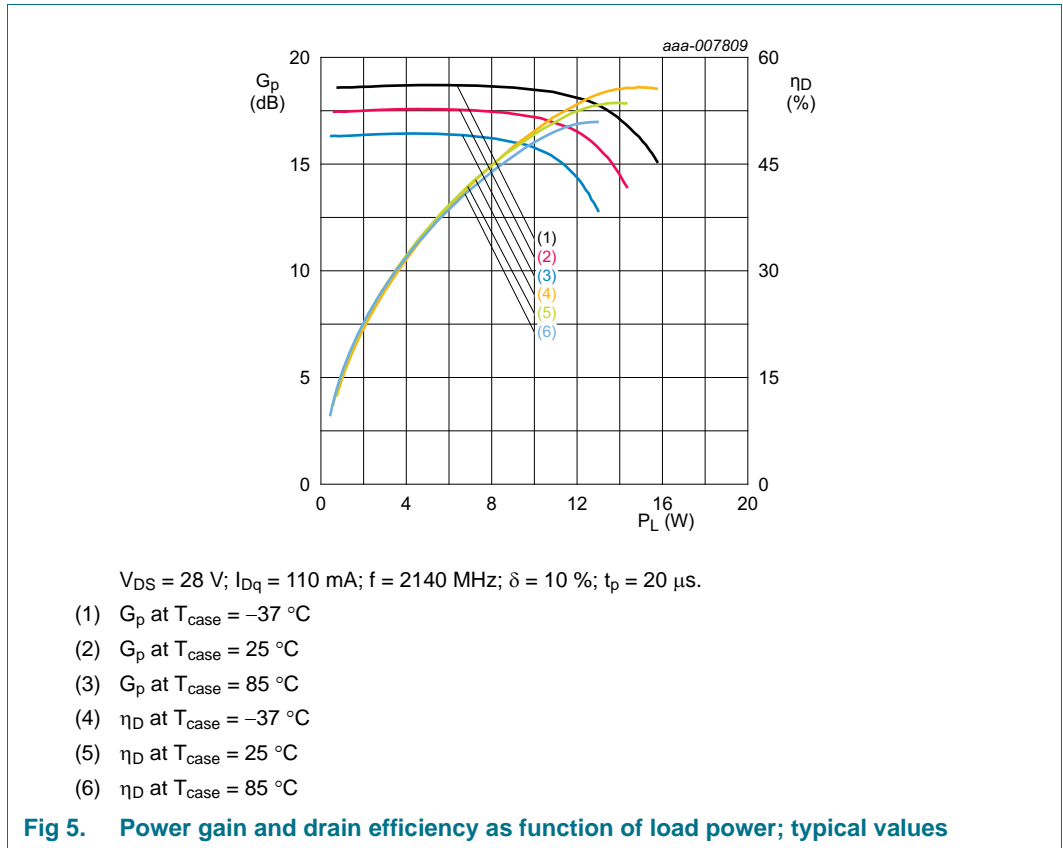

8.1.2.2 2-Carrier W-CDMA

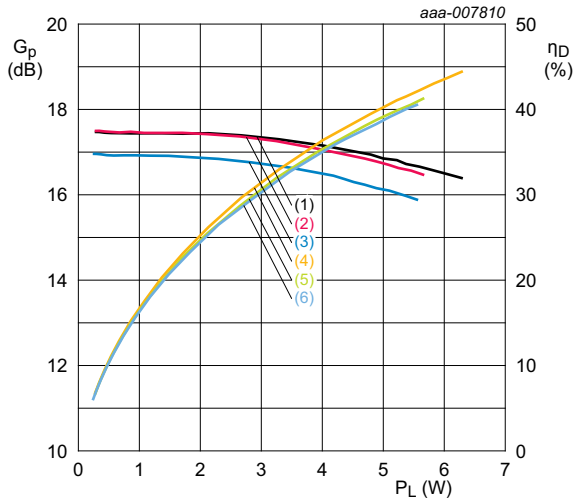

$V_{DS} = 28\text{ V}$ ;  $I_{DQ} = 110\text{ mA}$ ;  $T_{case} = 25\text{ }^\circ\text{C}$ ;  
 carrier spacing = 5 MHz; 46 % clipping; PAR = 8.4 dB at  
 0.01 % probability on CCDF.

- (1)  $G_p$  at  $f = 2110\text{ MHz}$
- (2)  $G_p$  at  $f = 2140\text{ MHz}$
- (3)  $G_p$  at  $f = 2170\text{ MHz}$
- (4)  $\eta_D$  at  $f = 2110\text{ MHz}$
- (5)  $\eta_D$  at  $f = 2140\text{ MHz}$
- (6)  $\eta_D$  at  $f = 2170\text{ MHz}$

Fig 6. Power gain and drain efficiency as function of load power; typical values

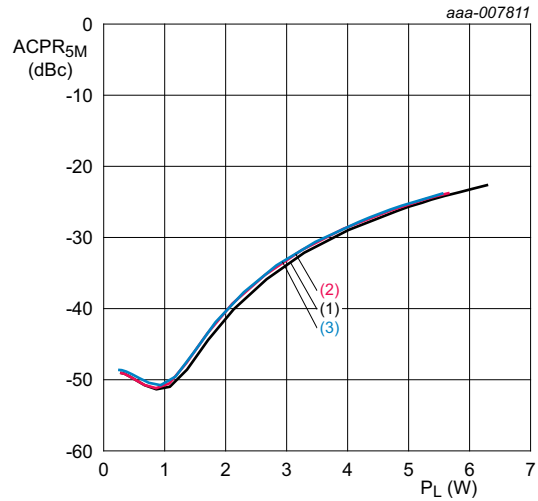

$V_{DS} = 28\text{ V}$ ;  $I_{DQ} = 110\text{ mA}$ ;  $T_{case} = 25\text{ }^\circ\text{C}$ ;  
 carrier spacing = 5 MHz; 46 % clipping; PAR = 8.4 dB at  
 0.01 % probability on CCDF.

- (1)  $f = 2110\text{ MHz}$
- (2)  $f = 2140\text{ MHz}$
- (3)  $f = 2170\text{ MHz}$

Fig 7. Adjacent channel power ratio (5 MHz) as a function of load power; typical values

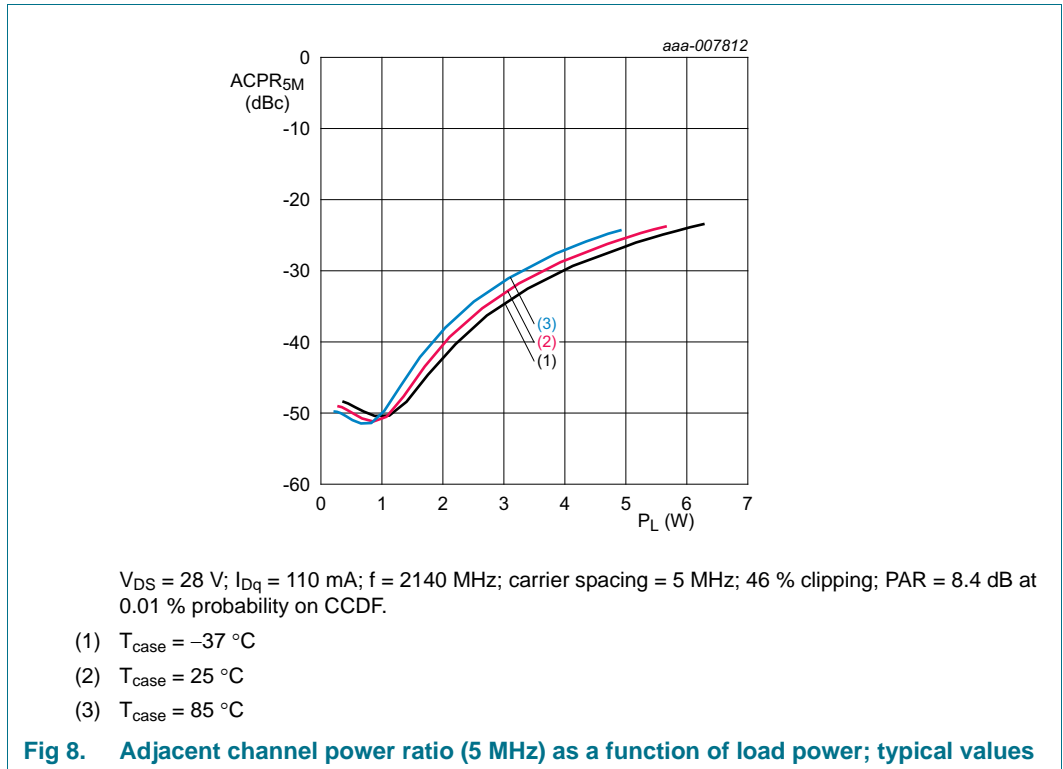

## 8.2 Frequency band 728 MHz to 768 MHz

### 8.2.1 Application circuit

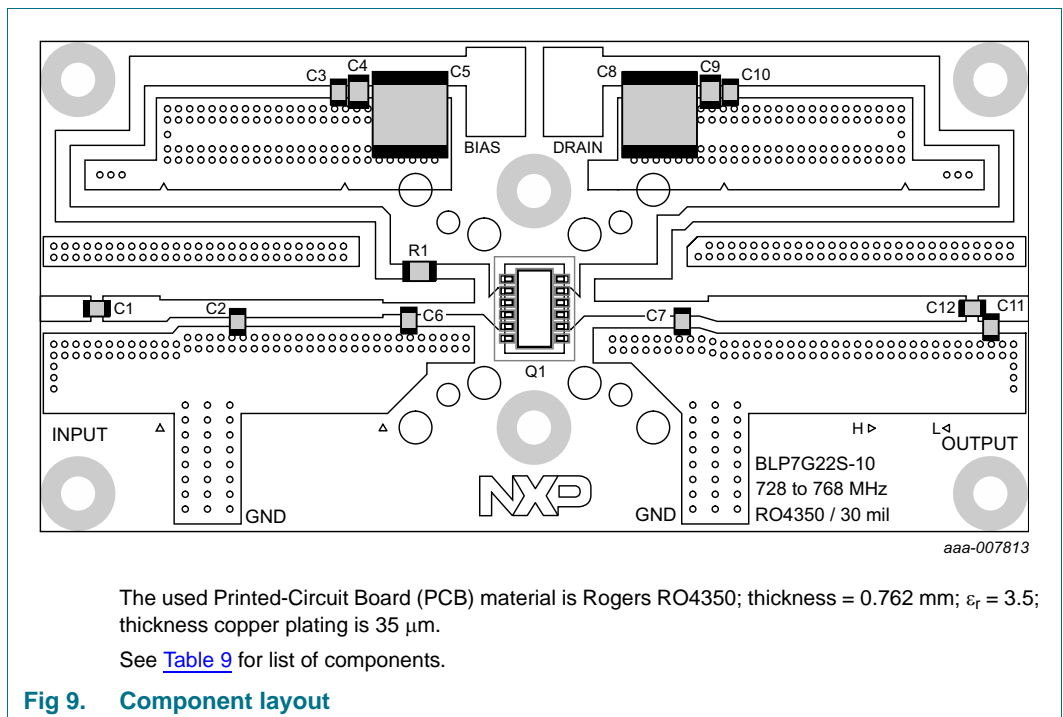



**Table 9. List of components**

See [Figure 9](#) for component layout.

The used Printed-Circuit Board (PCB) material is Rogers RO4350; thickness = 0.762 mm;  $\epsilon_r = 3.5$ ; thickness copper plating is 35  $\mu\text{m}$ .

Component	Description	Value	Remarks
C1, C12	multilayer ceramic chip capacitor	68 pF	[1]
C2	multilayer ceramic chip capacitor	10 pF	[1]
C3, C10	multilayer ceramic chip capacitor	100 pF	[1]
C4, C9	multilayer ceramic chip capacitor	100 nF	[2]
C5, C8	multilayer ceramic chip capacitor	10 $\mu\text{F}$ ; 50 V	[3]
C6	multilayer ceramic chip capacitor	36 pF	[1]
C7	multilayer ceramic chip capacitor	9.1 pF	[1]
C11	multilayer ceramic chip capacitor	7.5 pF	[1]
R1	chip resistor	5.1 $\Omega$	SMD 0805; 1 % tolerance

[1] American Technical Ceramics type 100A or capacitor of same quality.

[2] Murata GRM21BR71H104KA01L or capacitor of same quality.

[3] Murata GRM32ER71H106KA88L or capacitor of same quality.

## 8.2.2 Graphs

### 8.2.2.1 2-Carrier W-CDMA

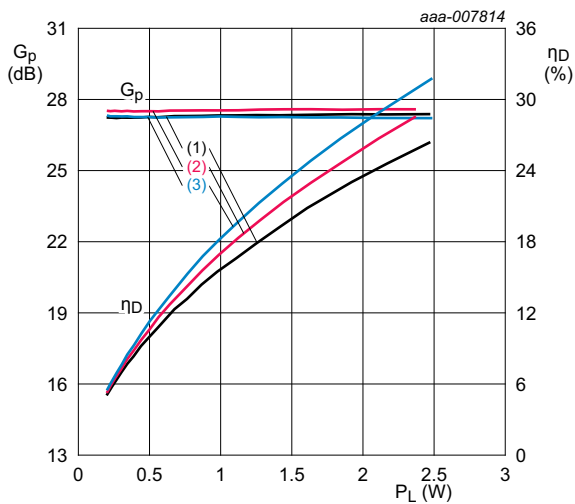

$V_{DS} = 28 \text{ V}$ ;  $I_{DQ} = 110 \text{ mA}$ ;  $T_{case} = 25 \text{ }^\circ\text{C}$ ;  
carrier spacing = 5 MHz; 46 % clipping; PAR = 8.4 dB at 0.01 % probability on CCDF.

- (1)  $f = 728 \text{ MHz}$
- (2)  $f = 748 \text{ MHz}$
- (3)  $f = 768 \text{ MHz}$

**Fig 10. Power gain and drain efficiency as function of load power; typical values**

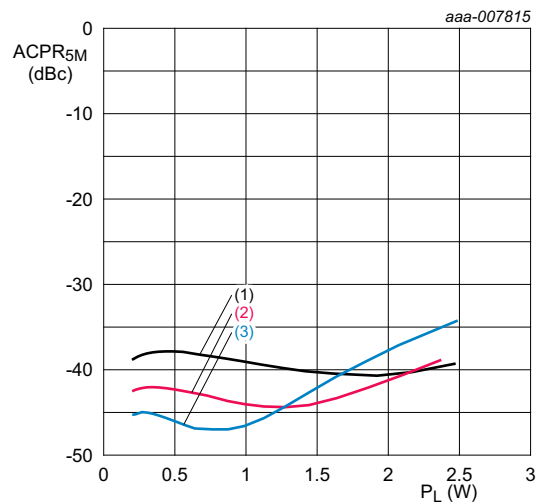

$V_{DS} = 28 \text{ V}$ ;  $I_{DQ} = 110 \text{ mA}$ ;  $T_{case} = 25 \text{ }^\circ\text{C}$ ;  
carrier spacing = 5 MHz; 46 % clipping; PAR = 8.4 dB at 0.01 % probability on CCDF.

- (1)  $f = 728 \text{ MHz}$
- (2)  $f = 748 \text{ MHz}$
- (3)  $f = 768 \text{ MHz}$

**Fig 11. Adjacent channel power ratio (5 MHz) as a function of load power; typical values**

## 9. Test information

---

### 9.1 Ruggedness in class-AB operation

The BLP7G22-10 is capable of withstanding a load mismatch corresponding to  $V_{SWR} = 10 : 1$  through all phases under the following conditions:  $V_{DS} = 28 \text{ V}$ ;  $I_{Dq} = 110 \text{ mA}$ ;  $P_L = 10 \text{ W}$ ; frequency from 700 MHz to 2700 MHz.

10. Package outline

HVSON12: plastic thermal enhanced very thin small outline package; no leads;  
12 terminals; body 6 x 4 x 0.85 mm

SOT1179-2

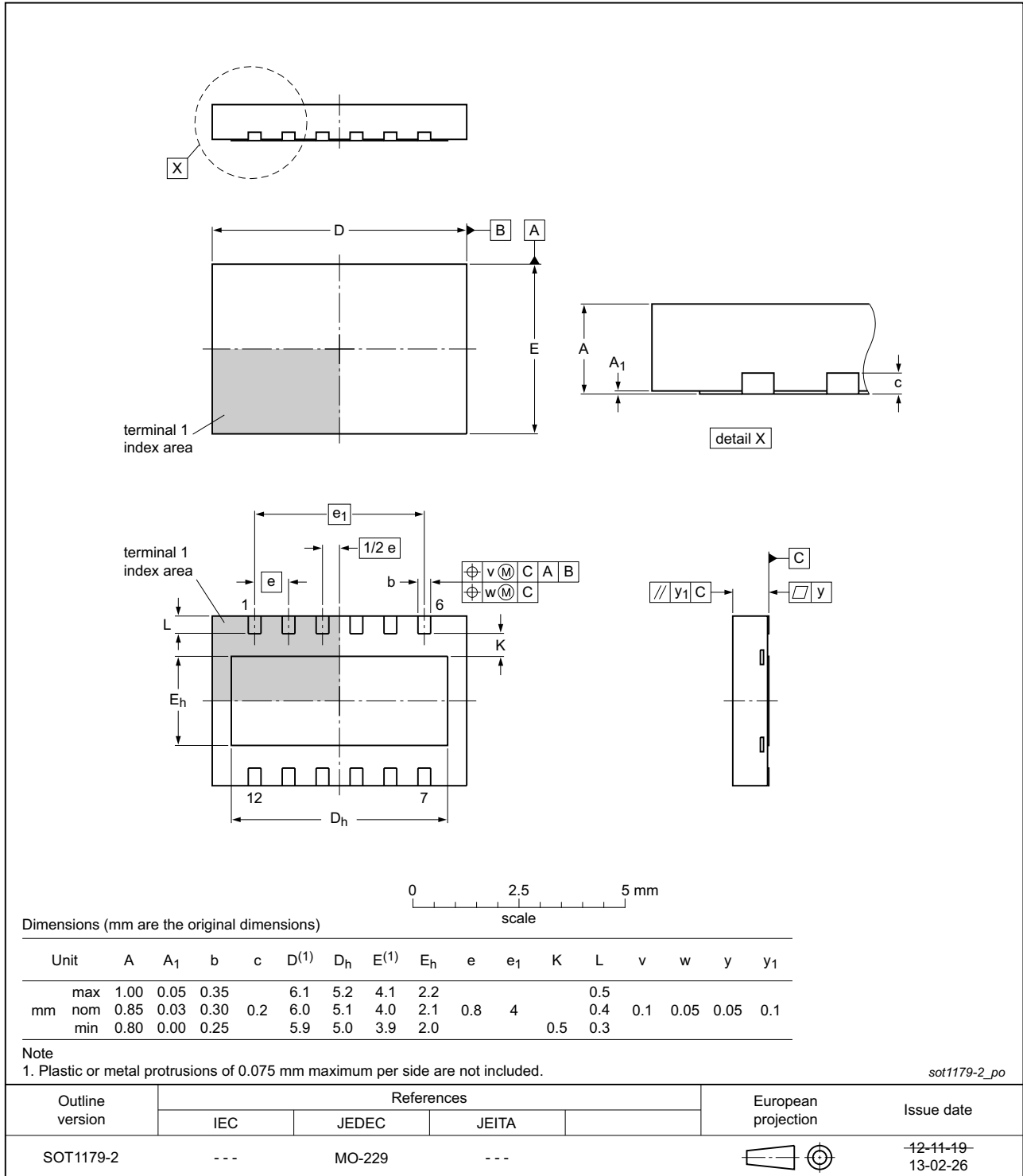

Fig 12. Package outline SOT1179-2 (HVSON12)

## 11. Handling information

### CAUTION



This device is sensitive to ElectroStatic Discharge (ESD). Observe precautions for handling electrostatic sensitive devices.

Such precautions are described in the *ANSI/ESD S20.20*, *IEC/ST 61340-5*, *JESD625-A* or equivalent standards.

## 12. Abbreviations

Table 10. Abbreviations

Acronym	Description
3GPP	3rd Generation Partnership Project
CCDF	Complementary Cumulative Distribution Function
CDMA	Code Division Multiple Access
CW	Continuous Wave
DPCH	Dedicated Physical CHannel
EDGE	Enhanced Data rates for GSM Evolution
ESD	ElectroStatic Discharge
GSM	Global System for Mobile Communication
LDMOS	Laterally Diffused Metal-Oxide Semiconductor
LTE	Long Term Evolution
MC-GSM	Multi Carrier GSM
PAR	Peak-to-Average Ratio
SMD	Surface Mounted Device
VSWR	Voltage Standing-Wave Ratio
W-CDMA	Wideband Code Division Multiple Access
WiMAX	Worldwide Interoperability for Microwave Access

## 13. Revision history

Table 11. Revision history

Document ID	Release date	Data sheet status	Change notice	Supersedes
BLP7G22-10 v.2	20130530	Product data sheet	-	BLP7G22-10 v.1
Modifications:	<ul style="list-style-type: none"><li>• <a href="#">Section 1 on page 1</a>: several changes have been made</li><li>• <a href="#">Section 2 on page 2</a>: several changes have been made</li><li>• <a href="#">Section 3 on page 2</a>: several changes have been made</li><li>• <a href="#">Section 5 on page 3</a>: section has been added</li><li>• <a href="#">Section 6 on page 3</a>: several changes have been made</li><li>• <a href="#">Section 7 on page 3</a>: several changes have been made</li><li>• <a href="#">Section 8 on page 4</a>: section has been added</li><li>• <a href="#">Section 9 on page 10</a>: section has been added</li><li>• <a href="#">Section 9.1 on page 10</a>: section has been moved here from <a href="#">Section 7 on page 3</a></li><li>• <a href="#">Section 10 on page 11</a>: the package outline has been changed</li></ul>			
BLP7G22-10 v.1	20120213	Objective data sheet	-	-

## 14. Legal information

### 14.1 Data sheet status

Document status <sup>[1][2]</sup>	Product status <sup>[3]</sup>	Definition
Objective [short] data sheet	Development	This document contains data from the objective specification for product development.
Preliminary [short] data sheet	Qualification	This document contains data from the preliminary specification.
Product [short] data sheet	Production	This document contains the product specification.

[1] Please consult the most recently issued document before initiating or completing a design.

[2] The term 'short data sheet' is explained in section "Definitions".

[3] The product status of device(s) described in this document may have changed since this document was published and may differ in case of multiple devices. The latest product status information is available on the Internet at URL <http://www.nxp.com>.

### 14.2 Definitions

**Draft** — The document is a draft version only. The content is still under internal review and subject to formal approval, which may result in modifications or additions. NXP Semiconductors does not give any representations or warranties as to the accuracy or completeness of information included herein and shall have no liability for the consequences of use of such information.

**Short data sheet** — A short data sheet is an extract from a full data sheet with the same product type number(s) and title. A short data sheet is intended for quick reference only and should not be relied upon to contain detailed and full information. For detailed and full information see the relevant full data sheet, which is available on request via the local NXP Semiconductors sales office. In case of any inconsistency or conflict with the short data sheet, the full data sheet shall prevail.

**Product specification** — The information and data provided in a Product data sheet shall define the specification of the product as agreed between NXP Semiconductors and its customer, unless NXP Semiconductors and customer have explicitly agreed otherwise in writing. In no event however, shall an agreement be valid in which the NXP Semiconductors product is deemed to offer functions and qualities beyond those described in the Product data sheet.

### 14.3 Disclaimers

**Limited warranty and liability** — Information in this document is believed to be accurate and reliable. However, NXP Semiconductors does not give any representations or warranties, expressed or implied, as to the accuracy or completeness of such information and shall have no liability for the consequences of use of such information. NXP Semiconductors takes no responsibility for the content in this document if provided by an information source outside of NXP Semiconductors.

In no event shall NXP Semiconductors be liable for any indirect, incidental, punitive, special or consequential damages (including - without limitation - lost profits, lost savings, business interruption, costs related to the removal or replacement of any products or rework charges) whether or not such damages are based on tort (including negligence), warranty, breach of contract or any other legal theory.

Notwithstanding any damages that customer might incur for any reason whatsoever, NXP Semiconductors' aggregate and cumulative liability towards customer for the products described herein shall be limited in accordance with the *Terms and conditions of commercial sale* of NXP Semiconductors.

**Right to make changes** — NXP Semiconductors reserves the right to make changes to information published in this document, including without limitation specifications and product descriptions, at any time and without notice. This document supersedes and replaces all information supplied prior to the publication hereof.

**Suitability for use** — NXP Semiconductors products are not designed, authorized or warranted to be suitable for use in life support, life-critical or safety-critical systems or equipment, nor in applications where failure or malfunction of an NXP Semiconductors product can reasonably be expected to result in personal injury, death or severe property or environmental damage. NXP Semiconductors and its suppliers accept no liability for inclusion and/or use of NXP Semiconductors products in such equipment or applications and therefore such inclusion and/or use is at the customer's own risk.

**Applications** — Applications that are described herein for any of these products are for illustrative purposes only. NXP Semiconductors makes no representation or warranty that such applications will be suitable for the specified use without further testing or modification.

Customers are responsible for the design and operation of their applications and products using NXP Semiconductors products, and NXP Semiconductors accepts no liability for any assistance with applications or customer product design. It is customer's sole responsibility to determine whether the NXP Semiconductors product is suitable and fit for the customer's applications and products planned, as well as for the planned application and use of customer's third party customer(s). Customers should provide appropriate design and operating safeguards to minimize the risks associated with their applications and products.

NXP Semiconductors does not accept any liability related to any default, damage, costs or problem which is based on any weakness or default in the customer's applications or products, or the application or use by customer's third party customer(s). Customer is responsible for doing all necessary testing for the customer's applications and products using NXP Semiconductors products in order to avoid a default of the applications and the products or of the application or use by customer's third party customer(s). NXP does not accept any liability in this respect.

**Limiting values** — Stress above one or more limiting values (as defined in the Absolute Maximum Ratings System of IEC 60134) will cause permanent damage to the device. Limiting values are stress ratings only and (proper) operation of the device at these or any other conditions above those given in the Recommended operating conditions section (if present) or the Characteristics sections of this document is not warranted. Constant or repeated exposure to limiting values will permanently and irreversibly affect the quality and reliability of the device.

**Terms and conditions of commercial sale** — NXP Semiconductors products are sold subject to the general terms and conditions of commercial sale, as published at <http://www.nxp.com/profile/terms>, unless otherwise agreed in a valid written individual agreement. In case an individual agreement is concluded only the terms and conditions of the respective agreement shall apply. NXP Semiconductors hereby expressly objects to applying the customer's general terms and conditions with regard to the purchase of NXP Semiconductors products by customer.

**No offer to sell or license** — Nothing in this document may be interpreted or construed as an offer to sell products that is open for acceptance or the grant, conveyance or implication of any license under any copyrights, patents or other industrial or intellectual property rights.

**Export control** — This document as well as the item(s) described herein may be subject to export control regulations. Export might require a prior authorization from competent authorities.

**Non-automotive qualified products** — Unless this data sheet expressly states that this specific NXP Semiconductors product is automotive qualified, the product is not suitable for automotive use. It is neither qualified nor tested in accordance with automotive testing or application requirements. NXP Semiconductors accepts no liability for inclusion and/or use of non-automotive qualified products in automotive equipment or applications.

In the event that customer uses the product for design-in and use in automotive applications to automotive specifications and standards, customer (a) shall use the product without NXP Semiconductors' warranty of the product for such automotive applications, use and specifications, and (b) whenever customer uses the product for automotive applications beyond

NXP Semiconductors' specifications such use shall be solely at customer's own risk, and (c) customer fully indemnifies NXP Semiconductors for any liability, damages or failed product claims resulting from customer design and use of the product for automotive applications beyond NXP Semiconductors' standard warranty and NXP Semiconductors' product specifications.

**Translations** — A non-English (translated) version of a document is for reference only. The English version shall prevail in case of any discrepancy between the translated and English versions.

## 14.4 Trademarks

Notice: All referenced brands, product names, service names and trademarks are the property of their respective owners.

## 15. Contact information

For more information, please visit: <http://www.nxp.com>

For sales office addresses, please send an email to: [salesaddresses@nxp.com](mailto:salesaddresses@nxp.com)

**16. Contents**

**1 Product profile . . . . . 1**

1.1 General description . . . . . 1

1.2 Features and benefits . . . . . 1

1.3 Applications . . . . . 1

**2 Pinning information . . . . . 2**

**3 Ordering information . . . . . 2**

**4 Limiting values . . . . . 2**

**5 Recommended operating conditions . . . . . 3**

**6 Thermal characteristics . . . . . 3**

**7 Characteristics . . . . . 3**

**8 Application information . . . . . 4**

8.1 Frequency band 2110 MHz to 2170 MHz . . . . . 4

8.1.1 Application circuit . . . . . 4

8.1.2 Graphs . . . . . 5

8.1.2.1 Pulsed CW . . . . . 5

8.1.2.2 2-Carrier W-CDMA . . . . . 7

8.2 Frequency band 728 MHz to 768 MHz . . . . . 8

8.2.1 Application circuit . . . . . 8

8.2.2 Graphs . . . . . 9

8.2.2.1 2-Carrier W-CDMA . . . . . 9

**9 Test information . . . . . 10**

9.1 Ruggedness in class-AB operation . . . . . 10

**10 Package outline . . . . . 11**

**11 Handling information . . . . . 12**

**12 Abbreviations . . . . . 12**

**13 Revision history . . . . . 13**

**14 Legal information . . . . . 14**

14.1 Data sheet status . . . . . 14

14.2 Definitions . . . . . 14

14.3 Disclaimers . . . . . 14

14.4 Trademarks . . . . . 15

**15 Contact information . . . . . 15**

**16 Contents . . . . . 16**

Please be aware that important notices concerning this document and the product(s) described herein, have been included in section 'Legal information'.