

BLS6G3135-120; BLS6G3135S-120

LDMOS S-Band radar power transistor

Rev. 02 — 29 May 2008

Product data sheet

1. Product profile

1.1 General description

120 W LDMOS power transistor intended for radar applications in the 3.1 GHz to 3.5 GHz range.

Table 1. Typical performance

Typical RF performance at $T_{case} = 25\text{ }^{\circ}\text{C}$; $t_p = 300\text{ }\mu\text{s}$; $\delta = 10\text{ }\%$; $I_{Dq} = 100\text{ mA}$; in a class-AB production test circuit.

| Mode of operation | f (GHz) | V _{DS} (V) | P _L (W) | G _p (dB) | η_D (%) | t _r (ns) | t _f (ns) |
|-------------------|------------|------------------------|-----------------------|------------------------|-----------------|------------------------|------------------------|
| pulsed RF | 3.1 to 3.5 | 32 | 120 | 11 | 43 | 20 | 6 |

CAUTION



This device is sensitive to ElectroStatic Discharge (ESD). Therefore care should be taken during transport and handling.

1.2 Features

- Typical pulsed RF performance at a frequency of 3.1 GHz to 3.5 GHz, a supply voltage of 32 V, an I_{Dq} of 100 mA, a t_p of up to 300 μs with δ of 10 %:
 - ◆ Output power = 120 W
 - ◆ Gain = 11 dB
 - ◆ Efficiency = 43 %
- Easy power control
- Integrated ESD protection
- Excellent ruggedness
- High efficiency
- Excellent thermal stability
- Designed for broadband operation (3.1 GHz to 3.5 GHz)
- Internally matched for ease of use
- Compliant to Directive 2002/95/EC, regarding Restriction of Hazardous Substances (RoHS)

1.3 Applications

- S-Band power amplifiers for radar applications in the 3.1 GHz to 3.5 GHz frequency range

2. Pinning information

Table 2. Pinning

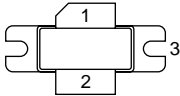
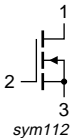
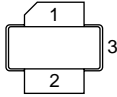
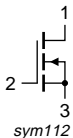
| Pin | Description | Simplified outline | Symbol |
|---------------------------------|-------------|---|--|
| BLS6G3135-120 (SOT502A) | | | |
| 1 | drain |  |  sym112 |
| 2 | gate | | |
| 3 | source | | |
| BLS6G3135S-120 (SOT502B) | | | |
| 1 | drain |  |  sym112 |
| 2 | gate | | |
| 3 | source | | |

[1] Connected to flange

3. Ordering information

Table 3. Ordering information

| Type number | Package | | |
|----------------|---------|---|---------|
| | Name | Description | Version |
| BLS6G3135-120 | - | flanged LDMOST ceramic package; 2 mounting holes; 2 leads | SOT502A |
| BLS6G3135S-120 | - | earless flanged LDMOST ceramic package; 2 leads | SOT502B |

4. Limiting values

Table 4. Limiting values

In accordance with the Absolute Maximum Rating System (IEC 60134).

| Symbol | Parameter | Min | Max | Unit |
|-----------|----------------------|------|------|------|
| V_{DS} | drain-source voltage | - | 60 | V |
| V_{GS} | gate-source voltage | -0.5 | +13 | V |
| I_D | drain current | - | 7.2 | A |
| T_{stg} | storage temperature | -65 | +150 | °C |
| T_j | junction temperature | - | 225 | °C |

5. Thermal characteristics

Table 5. Thermal characteristics

| Symbol | Parameter | Conditions | Typ | Max | Unit |
|----------------|--|---|------|------|------|
| $Z_{th(j-mb)}$ | transient thermal impedance from junction to mounting base | $T_{case} = 85\text{ °C}; P_L = 120\text{ W}$ | | | |
| | | $t_p = 300\text{ }\mu\text{s}; \delta = 10\%$ | 0.29 | 0.40 | K/W |
| | | $t_p = 100\text{ }\mu\text{s}; \delta = 20\%$ | 0.30 | 0.41 | K/W |

6. Characteristics

Table 6. Characteristics

$T_j = 25\text{ °C}$ unless otherwise specified.

| Symbol | Parameter | Conditions | Min | Typ | Max | Unit |
|---------------|----------------------------------|---|-----|-------|-------|---------------|
| $V_{(BR)DSS}$ | drain-source breakdown voltage | $V_{GS} = 0\text{ V}; I_D = 0.5\text{ mA}$ | 60 | - | - | V |
| $V_{GS(th)}$ | gate-source threshold voltage | $V_{DS} = 10\text{ V}; I_D = 180\text{ mA}$ | 1.4 | 1.8 | 2.3 | V |
| I_{DSS} | drain leakage current | $V_{GS} = 0\text{ V}; V_{DS} = 28\text{ V}$ | - | - | 5 | μA |
| I_{DSX} | drain cut-off current | $V_{GS} = V_{GS(th)} + 3.75\text{ V}; V_{DS} = 10\text{ V}$ | 27 | 33 | - | A |
| I_{GSS} | gate leakage current | $V_{GS} = 8.3\text{ V}; V_{DS} = 0\text{ V}$ | - | - | 450 | nA |
| g_{fs} | forward transconductance | $V_{DS} = 10\text{ V}; I_D = 9\text{ A}$ | - | 13 | - | S |
| $R_{DS(on)}$ | drain-source on-state resistance | $V_{GS} = V_{GS(th)} + 3.75\text{ V}; I_D = 6.3\text{ A}$ | - | 0.085 | 0.160 | Ω |

7. Application information

Table 7. Application information

Mode of operation: pulsed RF; $t_p = 300\text{ }\mu\text{s}; \delta = 10\%$; RF performance at $V_{DS} = 32\text{ V}; I_{Dq} = 100\text{ mA}; T_{case} = 25\text{ °C}$; unless otherwise specified, in a class-AB production circuit.

| Symbol | Parameter | Conditions | Min | Typ | Max | Unit |
|--------------|---------------------------------------|----------------------|-----|-----|-----|------|
| P_L | output power | | - | 120 | - | W |
| V_{CC} | supply voltage | $P_L = 120\text{ W}$ | - | - | 32 | V |
| G_p | power gain | $P_L = 120\text{ W}$ | 9.5 | 11 | - | dB |
| IRL | input return loss | $P_L = 120\text{ W}$ | 6 | 10 | - | dB |
| $P_{L(1dB)}$ | output power at 1 dB gain compression | $P_L = 120\text{ W}$ | - | 130 | - | W |
| η_D | drain efficiency | $P_L = 120\text{ W}$ | 39 | 43 | - | % |
| t_r | rise time | $P_L = 120\text{ W}$ | - | 20 | 50 | ns |
| t_f | fall time | $P_L = 120\text{ W}$ | - | 6 | 50 | ns |

Table 8. Typical impedance

| f GHz | Z _S Ω | Z _L Ω |
|----------|---------------------|---------------------|
| 3.1 | 2.7 – j5.4 | 5.9 – j5.9 |
| 3.2 | 3.3 – j4.7 | 4.5 – j6.2 |
| 3.3 | 4.2 – j4.4 | 3.5 – j6.0 |
| 3.4 | 5.2 – j4.8 | 2.7 – j5.6 |
| 3.5 | 5.7 – j6.2 | 2.0 – j5.2 |

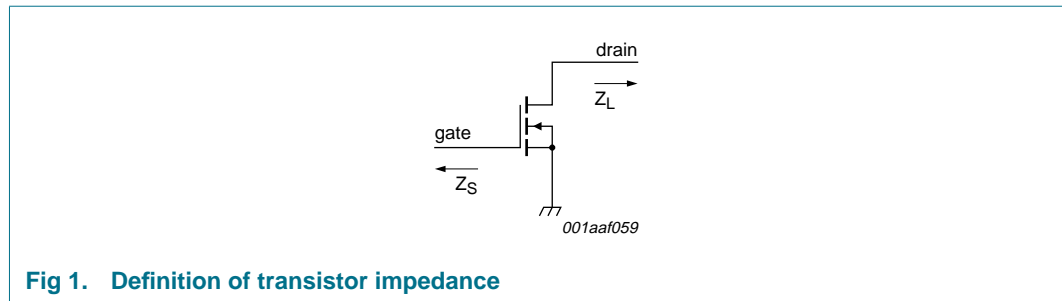
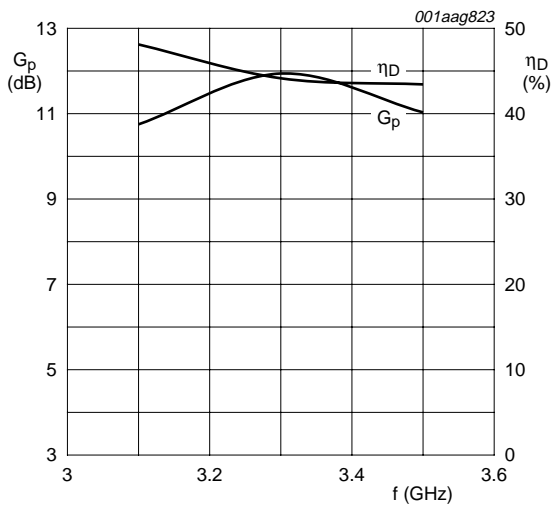

Fig 1. Definition of transistor impedance

7.1 Ruggedness in class-AB operation

The BLS6G3135-120 and BLS6G3135S-120 are capable of withstanding a load mismatch corresponding to VSWR = 5 : 1 through all phases under the following conditions: $V_{DS} = 32\text{ V}$; $I_{Dq} = 100\text{ mA}$; $P_L = 120\text{ W}$; $t_p = 300\text{ }\mu\text{s}$; $\delta = 10\text{ }\%$.



$V_{DS} = 32\text{ V}$; $I_{Dq} = 100\text{ mA}$; $t_p = 300\text{ }\mu\text{s}$; $\delta = 10\text{ }\%$;
 $P_L = 120\text{ W}$.

Fig 2. Power gain and drain efficiency as functions of frequency; typical values

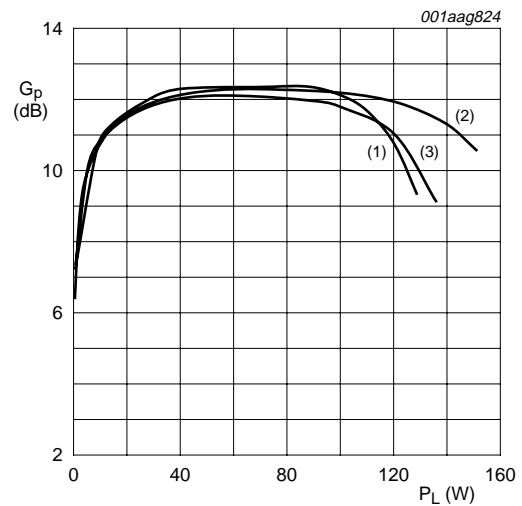

(1) $f = 3.1\text{ GHz}$
(2) $f = 3.3\text{ GHz}$
(3) $f = 3.5\text{ GHz}$
 $V_{DS} = 32\text{ V}$; $I_{Dq} = 100\text{ mA}$; $t_p = 300\text{ }\mu\text{s}$; $\delta = 10\text{ }\%$.

Fig 3. Power gain as a function of load power; typical values

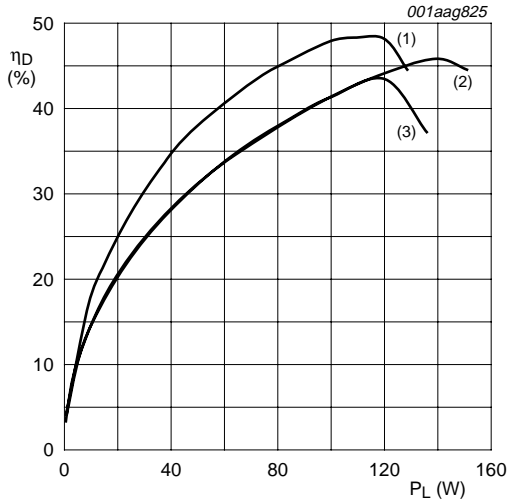

(1) $f = 3.1 \text{ GHz}$
 (2) $f = 3.3 \text{ GHz}$
 (3) $f = 3.5 \text{ GHz}$
 $V_{DS} = 32 \text{ V}; I_{Dq} = 100 \text{ mA}; t_p = 300 \mu\text{s}; \delta = 10 \%$.

Fig 4. Drain efficiency as a function of load power; typical values

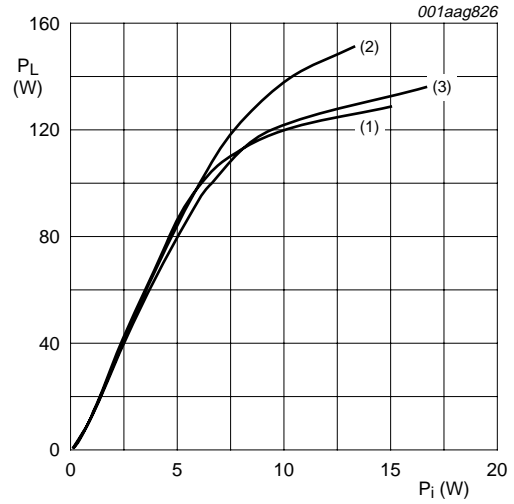

(1) $f = 3.1 \text{ GHz}$
 (2) $f = 3.3 \text{ GHz}$
 (3) $f = 3.5 \text{ GHz}$
 $V_{DS} = 32 \text{ V}; I_{Dq} = 100 \text{ mA}; t_p = 300 \mu\text{s}; \delta = 10 \%$.

Fig 5. Load power as a function of input power; typical values

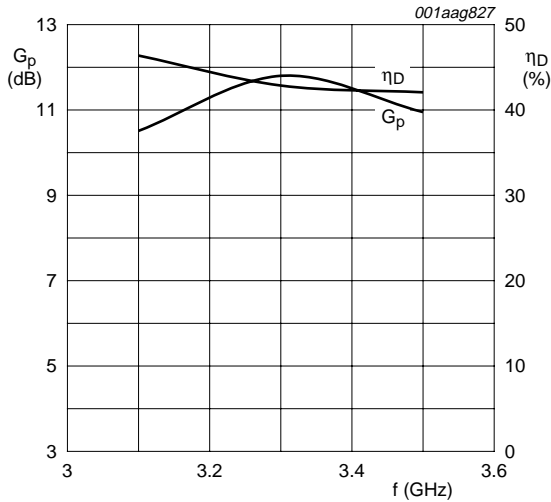

$V_{DS} = 32 \text{ V}; I_{Dq} = 100 \text{ mA}; t_p = 100 \mu\text{s}; \delta = 20 \%$;
 $P_L = 120 \text{ W}$.

Fig 6. Power gain and drain efficiency as functions of frequency; typical values

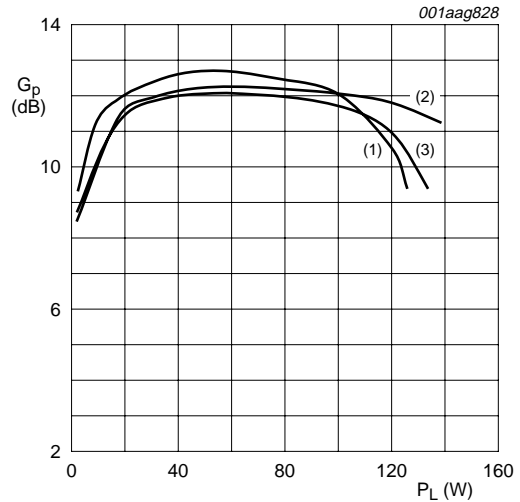

(1) $f = 3.1 \text{ GHz}$
 (2) $f = 3.3 \text{ GHz}$
 (3) $f = 3.5 \text{ GHz}$
 $V_{DS} = 32 \text{ V}; I_{Dq} = 100 \text{ mA}; t_p = 100 \mu\text{s}; \delta = 20 \%$.

Fig 7. Power gain as a function of load power; typical values

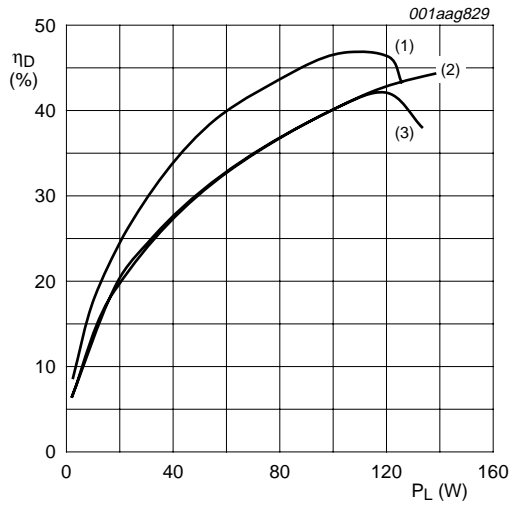

(1) $f = 3.1$ GHz
 (2) $f = 3.3$ GHz
 (3) $f = 3.5$ GHz
 $V_{DS} = 32$ V; $I_{Dq} = 100$ mA; $t_p = 100$ μ s; $\delta = 20$ %.

Fig 8. Drain efficiency as a function of load power; typical values

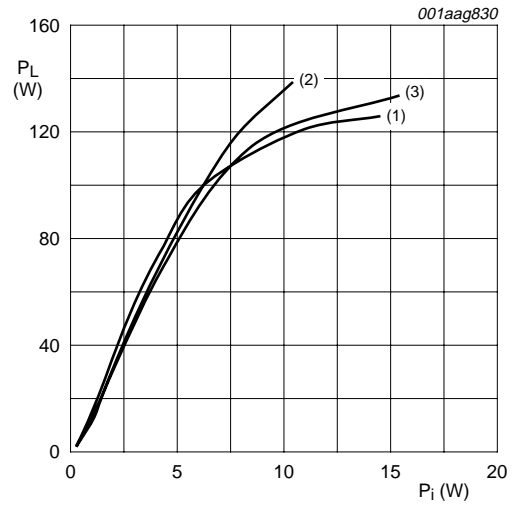

(1) $f = 3.1$ GHz
 (2) $f = 3.3$ GHz
 (3) $f = 3.5$ GHz
 $V_{DS} = 32$ V; $I_{Dq} = 100$ mA; $t_p = 100$ μ s; $\delta = 20$ %.

Fig 9. Load power as a function of input power; typical values

8. Test information

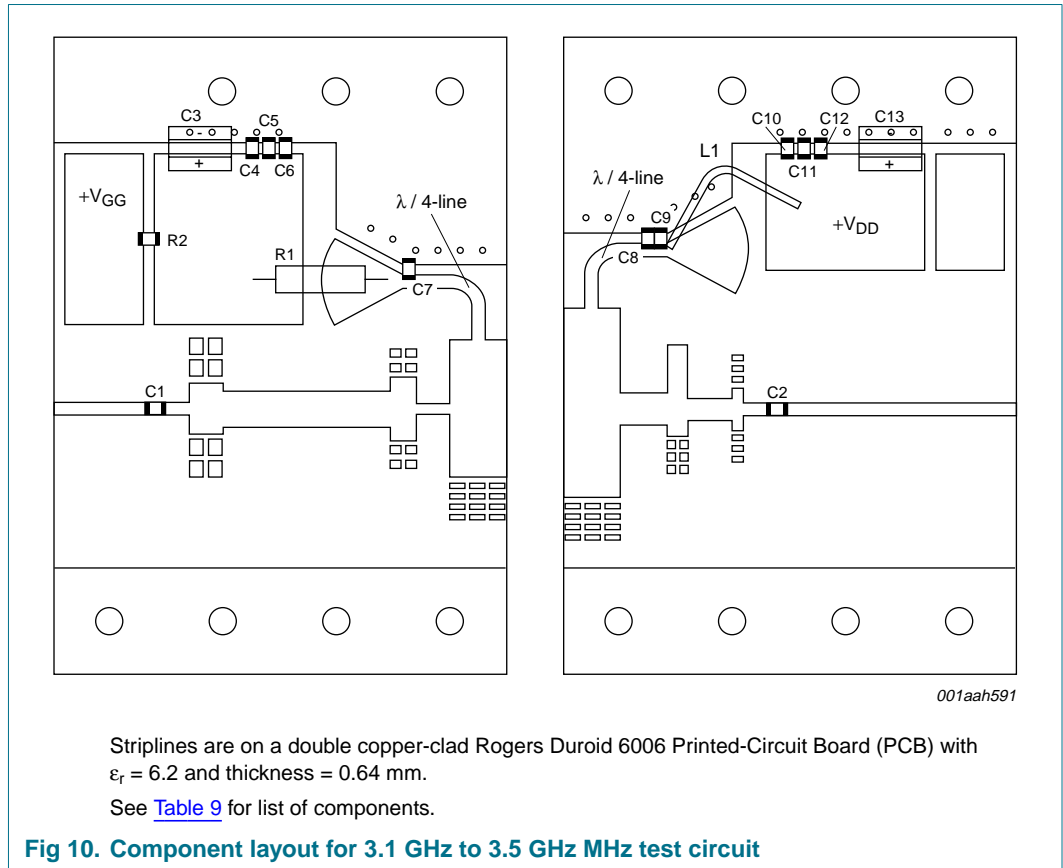

Table 9. List of components (see Figure 10)

To ensure good power supply of the device, adding an electrolytical capacitor close to the supply connection of the circuit may be required. The actual capacitor value may differ depending on the pulse format, the quality of the power supply and the length of the connecting wires to the power supply. In general a value of 470 μF will be sufficient.

| Component | Description | Value | Remarks |
|-------------------------------------|-----------------------------------|--------------------|---------|
| C1, C2, C4, C5, C6, C7, C8, C9, C11 | multilayer ceramic chip capacitor | 24 pF | [1] |
| C3 | electrolytic capacitor | 20 μF ; 20 V | |
| C10 | multilayer ceramic chip capacitor | 33 pF | [1] |
| C12 | multilayer ceramic chip capacitor | 1 nF | [2] |
| C13 | electrolytic capacitor | 100 μF ; 63 V | |
| L1 | copper wire | - | |
| R1 | resistor | 49.9 Ω | |
| R2 | SMD resistor | 49.9 Ω | |

[1] American Technical Ceramics type 100A or capacitor of same quality.

[2] American Technical Ceramics type 700A or capacitor of same quality.

9. Package outline

Flanged LDMOST ceramic package; 2 mounting holes; 2 leads

SOT502A

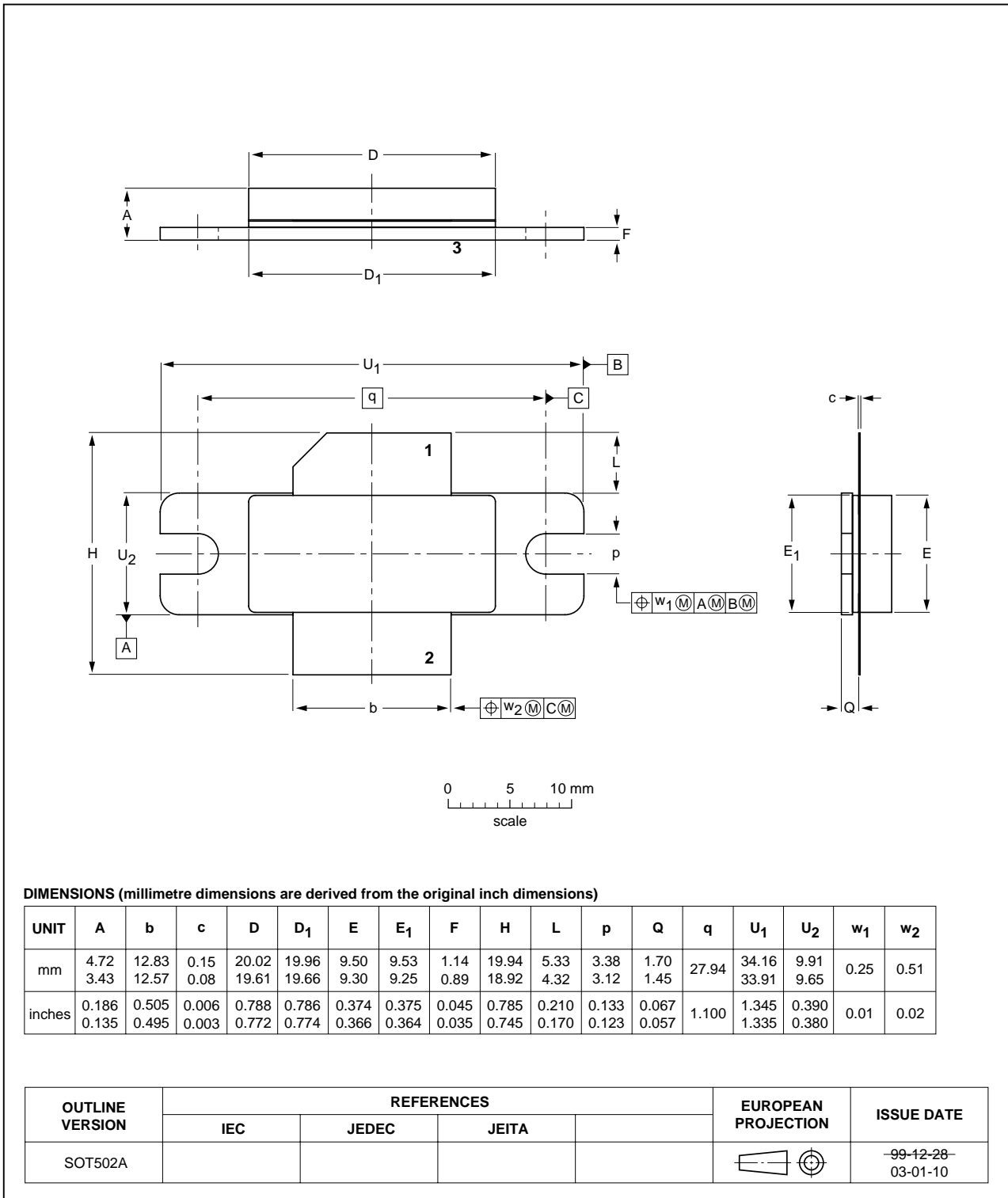

Fig 11. Package outline SOT502A

Earless flanged LDMOST ceramic package; 2 leads

SOT502B

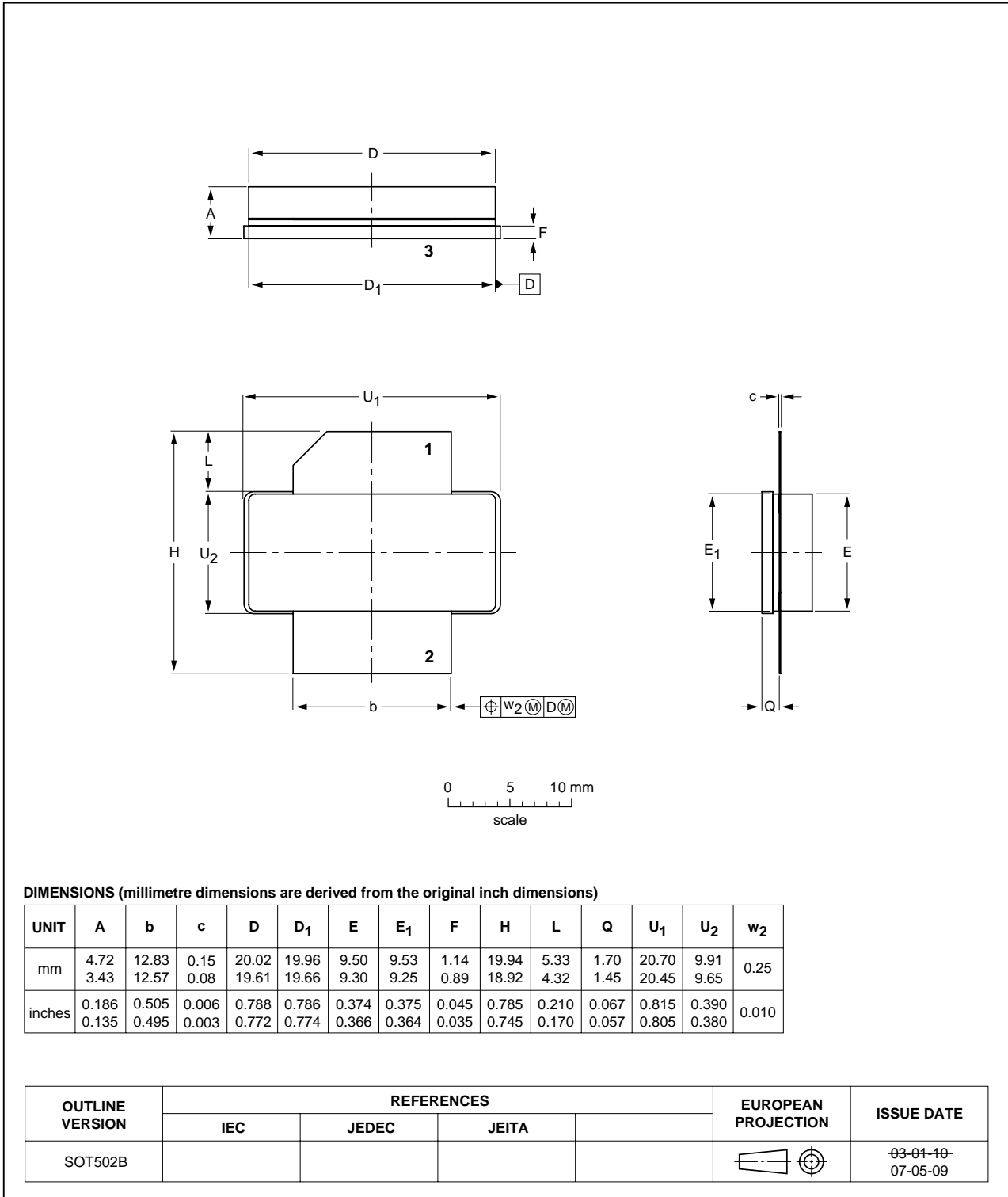

Fig 12. Package outline SOT502B

10. Abbreviations

Table 10. Abbreviations

| Acronym | Description |
|---------|---|
| LDMOS | Laterally Diffused Metal Oxide Semiconductor |
| LDMOST | Lateral Diffused Metal-Oxide Semiconductor Transistor |
| RF | Radio Frequency |
| S-Band | Short wave Band |
| VSWR | Voltage Standing-Wave Ratio |

11. Revision history

Table 11. Revision history

| Document ID | Release date | Data sheet status | Change notice | Supersedes |
|-----------------------------|---|------------------------|---------------|-----------------------------|
| BLS6G3135-120_6G3135S-120_2 | 20080529 | Product data sheet | - | BLS6G3135-120_6G3135S-120_1 |
| Modifications: | <ul style="list-style-type: none"> • Section 8 on page 7: Component layout was added | | | |
| BLS6G3135-120_6G3135S-120_1 | 20070814 | Preliminary data sheet | - | - |

12. Legal information

12.1 Data sheet status

| Document status ^{[1][2]} | Product status ^[3] | Definition |
|-----------------------------------|-------------------------------|---|
| Objective [short] data sheet | Development | This document contains data from the objective specification for product development. |
| Preliminary [short] data sheet | Qualification | This document contains data from the preliminary specification. |
| Product [short] data sheet | Production | This document contains the product specification. |

[1] Please consult the most recently issued document before initiating or completing a design.

[2] The term 'short data sheet' is explained in section "Definitions".

[3] The product status of device(s) described in this document may have changed since this document was published and may differ in case of multiple devices. The latest product status information is available on the Internet at URL <http://www.nxp.com>.

12.2 Definitions

Draft — The document is a draft version only. The content is still under internal review and subject to formal approval, which may result in modifications or additions. NXP Semiconductors does not give any representations or warranties as to the accuracy or completeness of information included herein and shall have no liability for the consequences of use of such information.

Short data sheet — A short data sheet is an extract from a full data sheet with the same product type number(s) and title. A short data sheet is intended for quick reference only and should not be relied upon to contain detailed and full information. For detailed and full information see the relevant full data sheet, which is available on request via the local NXP Semiconductors sales office. In case of any inconsistency or conflict with the short data sheet, the full data sheet shall prevail.

12.3 Disclaimers

General — Information in this document is believed to be accurate and reliable. However, NXP Semiconductors does not give any representations or warranties, expressed or implied, as to the accuracy or completeness of such information and shall have no liability for the consequences of use of such information.

Right to make changes — NXP Semiconductors reserves the right to make changes to information published in this document, including without limitation specifications and product descriptions, at any time and without notice. This document supersedes and replaces all information supplied prior to the publication hereof.

Suitability for use — NXP Semiconductors products are not designed, authorized or warranted to be suitable for use in medical, military, aircraft, space or life support equipment, nor in applications where failure or

malfunction of an NXP Semiconductors product can reasonably be expected to result in personal injury, death or severe property or environmental damage. NXP Semiconductors accepts no liability for inclusion and/or use of NXP Semiconductors products in such equipment or applications and therefore such inclusion and/or use is at the customer's own risk.

Applications — Applications that are described herein for any of these products are for illustrative purposes only. NXP Semiconductors makes no representation or warranty that such applications will be suitable for the specified use without further testing or modification.

Limiting values — Stress above one or more limiting values (as defined in the Absolute Maximum Ratings System of IEC 60134) may cause permanent damage to the device. Limiting values are stress ratings only and operation of the device at these or any other conditions above those given in the Characteristics sections of this document is not implied. Exposure to limiting values for extended periods may affect device reliability.

Terms and conditions of sale — NXP Semiconductors products are sold subject to the general terms and conditions of commercial sale, as published at <http://www.nxp.com/profile/terms>, including those pertaining to warranty, intellectual property rights infringement and limitation of liability, unless explicitly otherwise agreed to in writing by NXP Semiconductors. In case of any inconsistency or conflict between information in this document and such terms and conditions, the latter will prevail.

No offer to sell or license — Nothing in this document may be interpreted or construed as an offer to sell products that is open for acceptance or the grant, conveyance or implication of any license under any copyrights, patents or other industrial or intellectual property rights.

12.4 Trademarks

Notice: All referenced brands, product names, service names and trademarks are the property of their respective owners.

13. Contact information

For additional information, please visit: <http://www.nxp.com>

For sales office addresses, send an email to: salesaddresses@nxp.com

14. Contents

| | | |
|-----------|--|-----------|
| 1 | Product profile | 1 |
| 1.1 | General description | 1 |
| 1.2 | Features | 1 |
| 1.3 | Applications | 2 |
| 2 | Pinning information | 2 |
| 3 | Ordering information | 2 |
| 4 | Limiting values | 2 |
| 5 | Thermal characteristics | 3 |
| 6 | Characteristics | 3 |
| 7 | Application information | 3 |
| 7.1 | Ruggedness in class-AB operation | 4 |
| 8 | Test information | 7 |
| 9 | Package outline | 8 |
| 10 | Abbreviations | 10 |
| 11 | Revision history | 10 |
| 12 | Legal information | 11 |
| 12.1 | Data sheet status | 11 |
| 12.2 | Definitions | 11 |
| 12.3 | Disclaimers | 11 |
| 12.4 | Trademarks | 11 |
| 13 | Contact information | 11 |
| 14 | Contents | 12 |

Please be aware that important notices concerning this document and the product(s) described herein, have been included in section 'Legal information'.



© NXP B.V. 2008.

All rights reserved.

For more information, please visit: <http://www.nxp.com>

For sales office addresses, please send an email to: salesaddresses@nxp.com

Date of release: 29 May 2008

Document identifier: BLS6G3135-120_6G3135S-120_2