

BLS6G3135-20; BLS6G3135S-20

LDMOS S-Band radar power transistor

Rev. 03 — 3 March 2009

Product data sheet

1. Product profile

1.1 General description

20 W LDMOS power transistor intended for radar applications in the 3.1 GHz to 3.5 GHz range.

Table 1. Typical performance

Typical RF performance at $T_{case} = 25\text{ }^{\circ}\text{C}$; $t_p = 300\text{ }\mu\text{s}$; $\delta = 10\%$; $I_{Dq} = 50\text{ mA}$; in a class-AB production test circuit.

Mode of operation	f (GHz)	V _{DS} (V)	P _L (W)	G _p (dB)	η_D (%)	t _r (ns)	t _f (ns)
Pulsed RF	3.1 to 3.5	32	20	15.5	45	20	10

CAUTION



This device is sensitive to ElectroStatic Discharge (ESD). Therefore care should be taken during transport and handling.

1.2 Features

- Typical pulsed RF performance at a frequency of 3.1 GHz to 3.5 GHz, a supply voltage of 32 V, an I_{Dq} of 50 mA, a t_p of 300 μs and a δ of 10 %:
 - ◆ Output power = 20 W
 - ◆ Power gain = 15.5 dB
 - ◆ Efficiency = 45 %
- Integrated ESD protection
- Excellent ruggedness
- High efficiency
- Excellent thermal stability
- Designed for broadband operation (3.1 GHz to 3.5 GHz)
- Internally matched for ease of use
- Compliant to Directive 2002/95/EC, regarding Restriction of Hazardous Substances (RoHS)

1.3 Applications

- S-Band power amplifiers for radar applications in the 3.1 GHz to 3.5 GHz frequency range

2. Pinning information

Table 2. Pinning

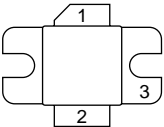
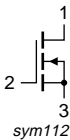
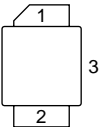
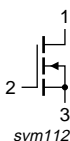
Pin	Description	Simplified outline	Graphic symbol
BLS6G3135-20 (SOT608A)			
1	drain		 sym112
2	gate		
3	source		
BLS6G3135S-20 (SOT608B)			
1	drain		 sym112
2	gate		
3	source		

[1] Connected to flange.

3. Ordering information

Table 3. Ordering information

Type number	Package		
	Name	Description	Version
BLS6G3135-20	-	flanged ceramic package; 2 mounting holes; 2 leads	SOT608A
BLS6G3135S-20	-	ceramic earless flanged package; 2 leads	SOT608B

4. Limiting values

Table 4. Limiting values

In accordance with the Absolute Maximum Rating System (IEC 60134).

Symbol	Parameter	Conditions	Min	Max	Unit
V_{DS}	drain-source voltage		-	60	V
V_{GS}	gate-source voltage		-0.5	+13	V
I_D	drain current		-	2.1	A
T_{stg}	storage temperature		-65	+150	°C
T_j	junction temperature		-	225	°C

5. Thermal characteristics

Table 5. Thermal characteristics

Symbol	Parameter	Conditions	Typ	Max	Unit
$R_{th(j-case)}$	thermal resistance from junction to case	$T_{case} = 80\text{ °C}; P_L = 20\text{ W}$			
		$t_p = 100\text{ }\mu\text{s}; \delta = 20\text{ \%}$	0.76	0.92	K/W
		$t_p = 300\text{ }\mu\text{s}; \delta = 10\text{ \%}$	0.79	0.95	K/W

6. Characteristics

Table 6. Characteristics

$T_j = 25\text{ °C}$ unless otherwise specified.

Symbol	Parameter	Conditions	Min	Typ	Max	Unit
$V_{(BR)DSS}$	drain-source breakdown voltage	$V_{GS} = 0\text{ V}; I_D = 0.5\text{ mA}$	60	-	-	V
$V_{GS(th)}$	gate-source threshold voltage	$V_{DS} = 10\text{ V}; I_D = 40\text{ mA}$	1.4	2	2.4	V
I_{DSS}	drain leakage current	$V_{GS} = 0\text{ V}; V_{DS} = 28\text{ V}$	-	-	1.5	μA
I_{DSX}	drain cut-off current	$V_{GS} = V_{GS(th)} + 3.75\text{ V}; V_{DS} = 10\text{ V}$	6	8.2	-	A
I_{GSS}	gate leakage current	$V_{GS} = 8.3\text{ V}; V_{DS} = 0\text{ V}$	-	-	150	nA
g_{fs}	forward transconductance	$V_{DS} = 10\text{ V}; I_D = 1.4\text{ A}$	-	2.8	-	S
$R_{DS(on)}$	drain-source on-state resistance	$V_{GS} = V_{GS(th)} + 3.75\text{ V}; I_D = 1.4\text{ A}$	-	0.37	0.58	Ω

7. Application information

Table 7. Application information

Mode of operation: pulsed RF; $t_p = 300\text{ }\mu\text{s}; \delta = 10\text{ \%}$; RF performance at $V_{DS} = 32\text{ V}; I_{Dq} = 50\text{ mA}$; $T_{case} = 25\text{ °C}$; unless otherwise specified; in a class-AB production circuit.

Symbol	Parameter	Conditions	Min	Typ	Max	Unit
P_L	output power		-	20	-	W
V_{CC}	supply voltage	$P_L = 20\text{ W}$	-	-	32	V
G_p	power gain	$P_L = 20\text{ W}$	12	15.5	-	dB
η_D	drain efficiency	$P_L = 20\text{ W}$	40	45	-	%
t_r	rise time	$P_L = 20\text{ W}$	-	20	50	ns
t_f	fall time	$P_L = 20\text{ W}$	-	10	50	ns

7.1 Impedance information

Table 8. Typical impedance

f GHz	Z _S Ω	Z _L (optimized for η _D) Ω	Z _L (optimized for G _p) Ω	G _{p(opt)} dB	η _D [1] %
3.1	31.24 – j31.07	6.99 + j12.9	13.01 + j14.75	18.08	48.34
3.2	50.56 – j12.48	5.82 + j8.77	11.47 + j11.17	17.97	45.60
3.3	43.66 + j17.27	2.32 + j6.17	10.05 + j10.55	17.75	47.01
3.4	24.13 + j28.47	5.52 + j6.10	9.93 + j8.48	17.91	47.03
3.5	10.56 + j22.21	5.79 + j3.19	9.37 + j5.73	17.68	46.54

[1] Measured with Z_L optimized for G_p.

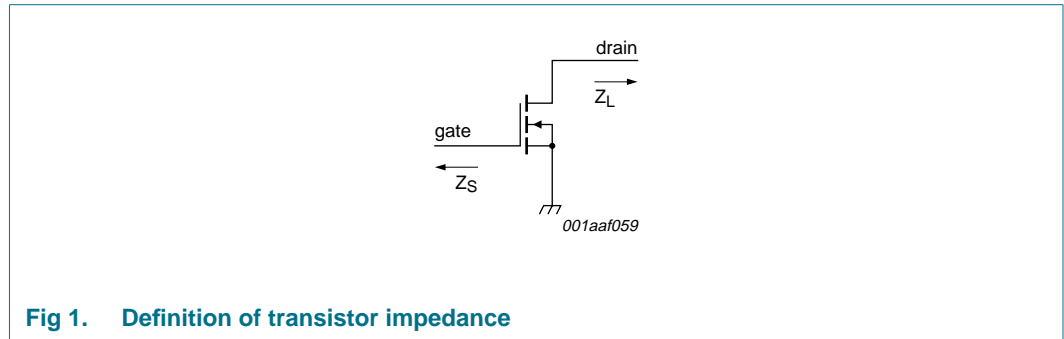
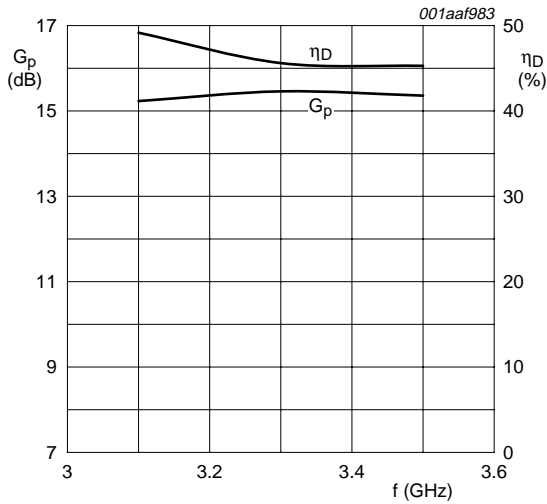

Fig 1. Definition of transistor impedance

7.2 Ruggedness in class-AB operation

The BLS6G3135-20 and BLS6G3135S-20 are capable of withstanding a load mismatch corresponding to VSWR = 5 : 1 through all phases under the following conditions: V_{DS} = 32 V; I_{Dq} = 50 mA; P_L = 20 W; t_p = 300 μs; δ = 10 %.

7.3 Graphs



$V_{DS} = 32\text{ V}$; $I_{Dq} = 50\text{ mA}$; $t_p = 300\ \mu\text{s}$; $\delta = 10\%$;
 $P_L = 20\text{ W}$.

Fig 2. Power gain and drain efficiency as functions of frequency; typical values

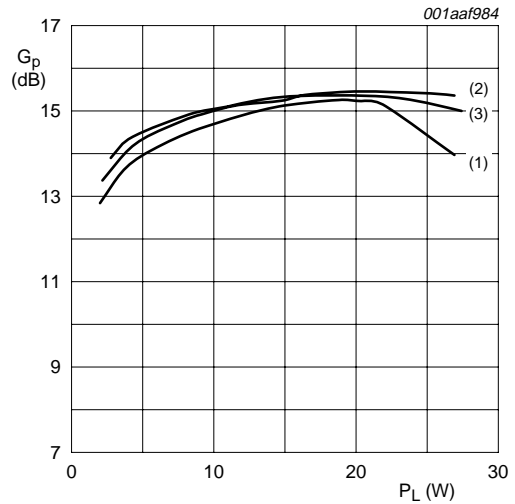

$V_{DS} = 32\text{ V}$; $I_{Dq} = 50\text{ mA}$; $t_p = 300\ \mu\text{s}$; $\delta = 10\%$.

- (1) $f = 3.1\text{ GHz}$
- (2) $f = 3.3\text{ GHz}$
- (3) $f = 3.5\text{ GHz}$

Fig 3. Power gain as a function of load power; typical values

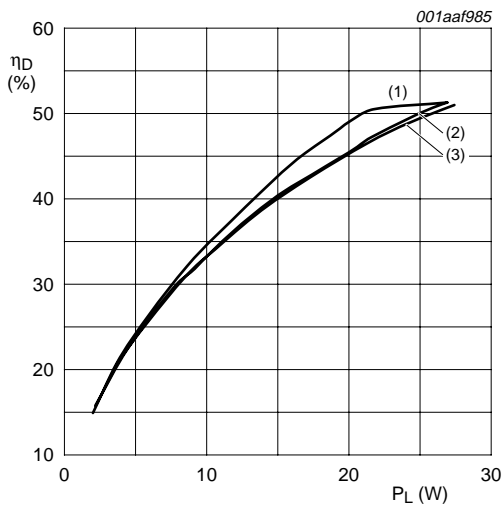

$V_{DS} = 32\text{ V}$; $I_{Dq} = 50\text{ mA}$; $t_p = 300\ \mu\text{s}$; $\delta = 10\%$.

- (1) $f = 3.1\text{ GHz}$
- (2) $f = 3.3\text{ GHz}$
- (3) $f = 3.5\text{ GHz}$

Fig 4. Efficiency as a function of load power; typical values

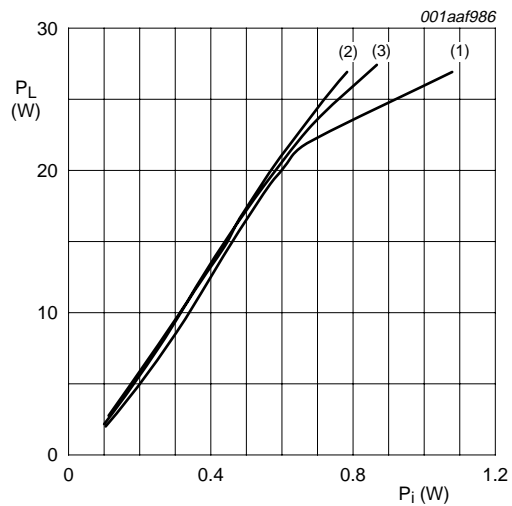

$V_{DS} = 32\text{ V}$; $I_{Dq} = 50\text{ mA}$; $t_p = 300\ \mu\text{s}$; $\delta = 10\%$.

- (1) $f = 3.1\text{ GHz}$
- (2) $f = 3.3\text{ GHz}$
- (3) $f = 3.5\text{ GHz}$

Fig 5. Load power as a function of input power; typical values

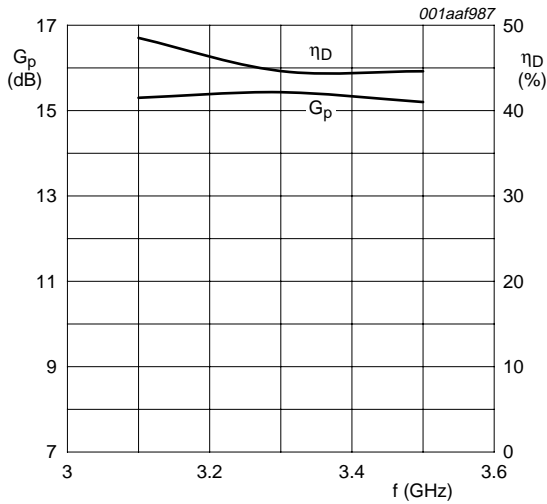

$V_{DS} = 32\text{ V}$; $I_{Dq} = 100\text{ mA}$; $t_p = 50\text{ }\mu\text{s}$; $\delta = 20\text{ }\%$;
 $P_L = 20\text{ W}$.

Fig 6. Power gain and drain efficiency as functions of frequency; typical values

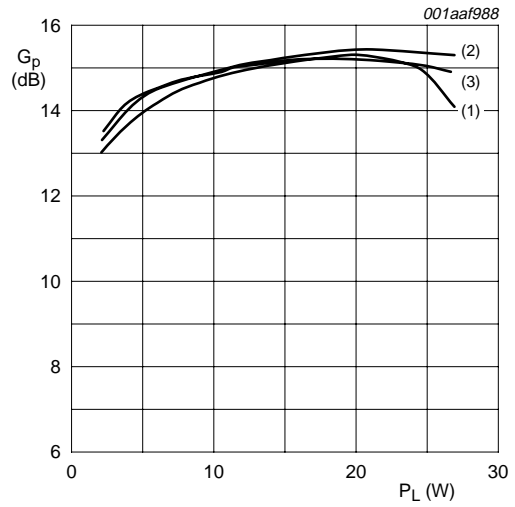

$V_{DS} = 32\text{ V}$; $I_{Dq} = 50\text{ mA}$; $t_p = 100\text{ }\mu\text{s}$; $\delta = 20\text{ }\%$.

- (1) $f = 3.1\text{ GHz}$
- (2) $f = 3.3\text{ GHz}$
- (3) $f = 3.5\text{ GHz}$

Fig 7. Power gain as a function of load power; typical values

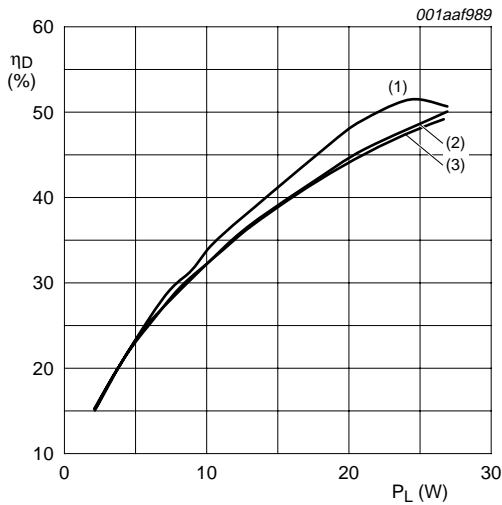

$V_{DS} = 32\text{ V}$; $I_{Dq} = 50\text{ mA}$; $t_p = 100\text{ }\mu\text{s}$; $\delta = 20\text{ }\%$.

- (1) $f = 3.1\text{ GHz}$
- (2) $f = 3.3\text{ GHz}$
- (3) $f = 3.5\text{ GHz}$

Fig 8. Efficiency as a function of load power; typical values

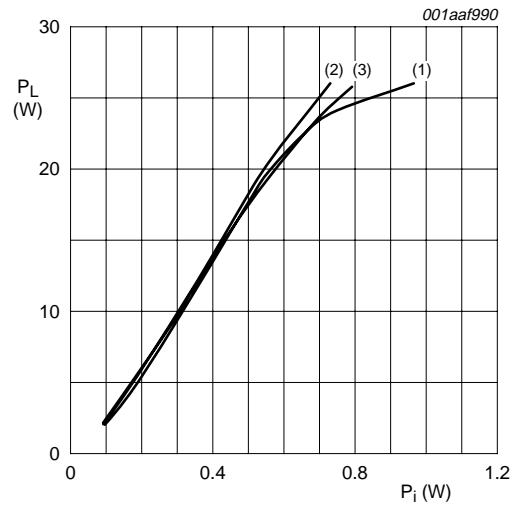

$V_{DS} = 32\text{ V}$; $I_{Dq} = 50\text{ mA}$; $t_p = 100\text{ }\mu\text{s}$; $\delta = 20\text{ }\%$.

- (1) $f = 3.1\text{ GHz}$
- (2) $f = 3.3\text{ GHz}$
- (3) $f = 3.5\text{ GHz}$

Fig 9. Load power as a function of input power; typical values

8. Test information

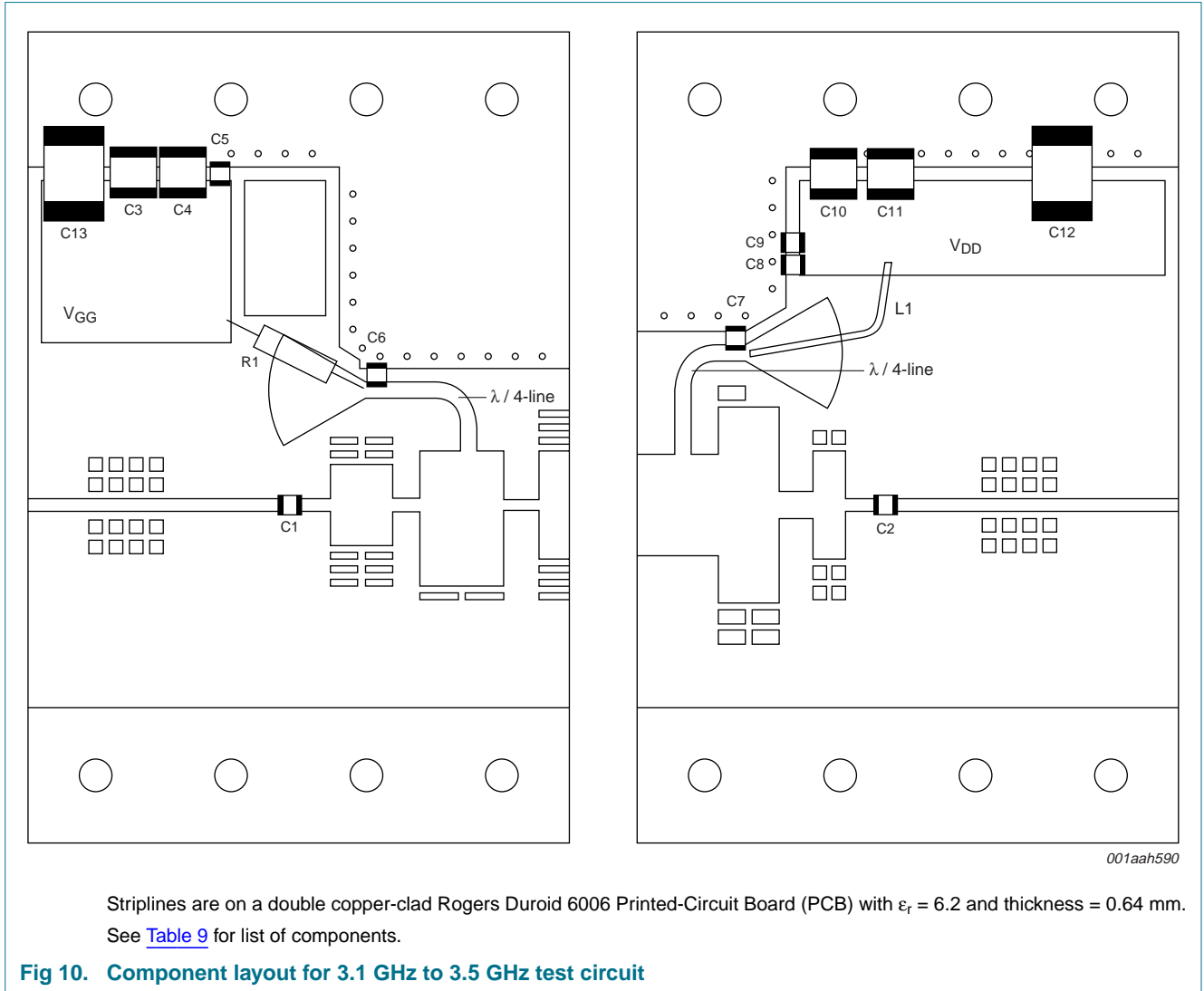

Table 9. List of components

See [Figure 10](#).

Component	Description	Value	Remarks
C1, C2, C5, C6, C7, C8, C9	multilayer ceramic chip capacitor	33 pF	[1]
C3, C4, C10, C11	multilayer ceramic chip capacitor	470 pF	[2]
C12	electrolytic capacitor	47 μ F; 63 V	
C13	electrolytic capacitor	10 μ F; 35 V	
L1	copper wire	-	
R1	resistor	49.9 Ω	

[1] American Technical Ceramics type 100A or capacitor of same quality.

[2] American Technical Ceramics type 100B or capacitor of same quality.

9. Package outline

Flanged ceramic package; 2 mounting holes; 2 leads

SOT608A

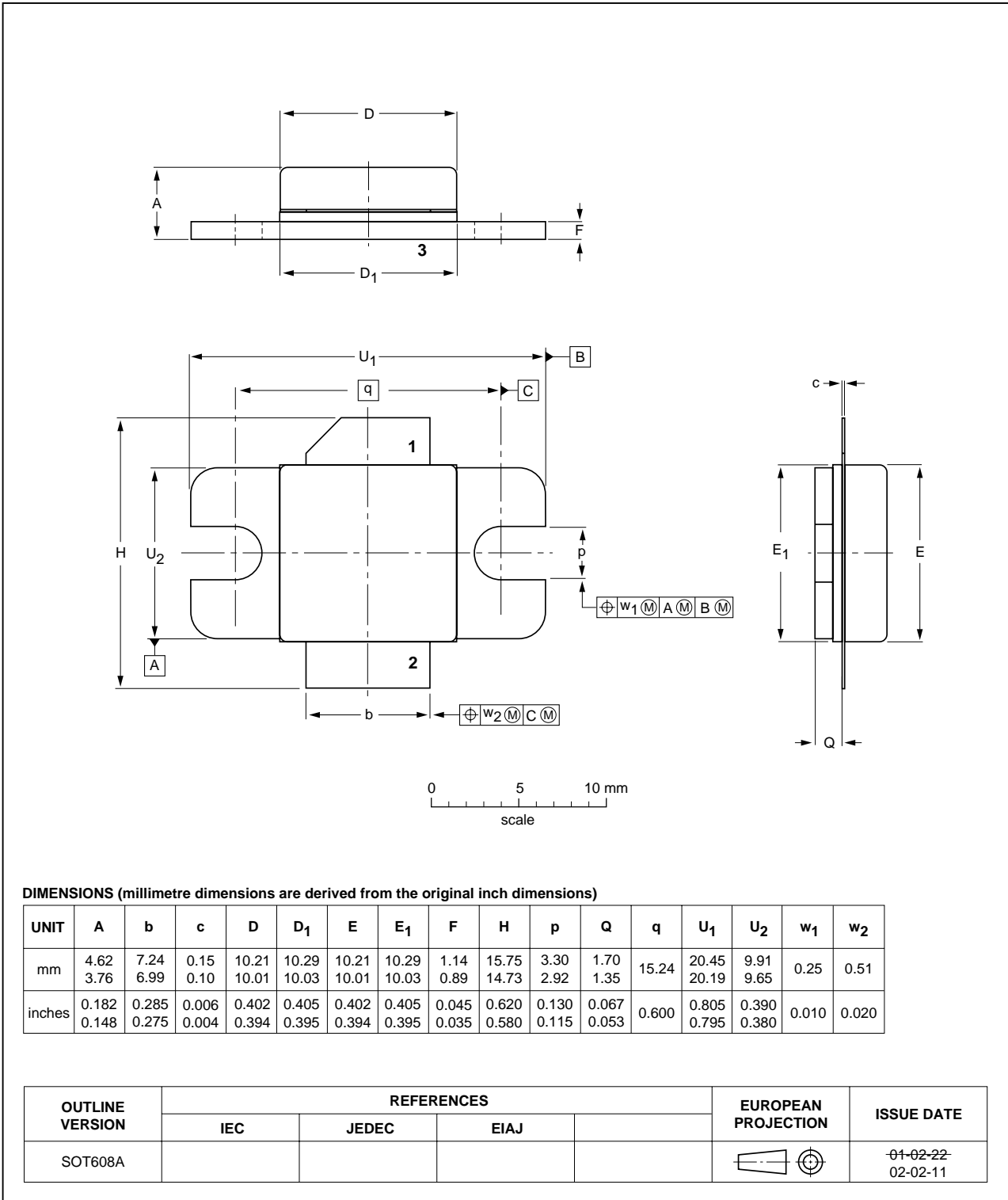

Fig 11. Package outline SOT608A

Ceramic earless flanged package; 2 leads

SOT608B

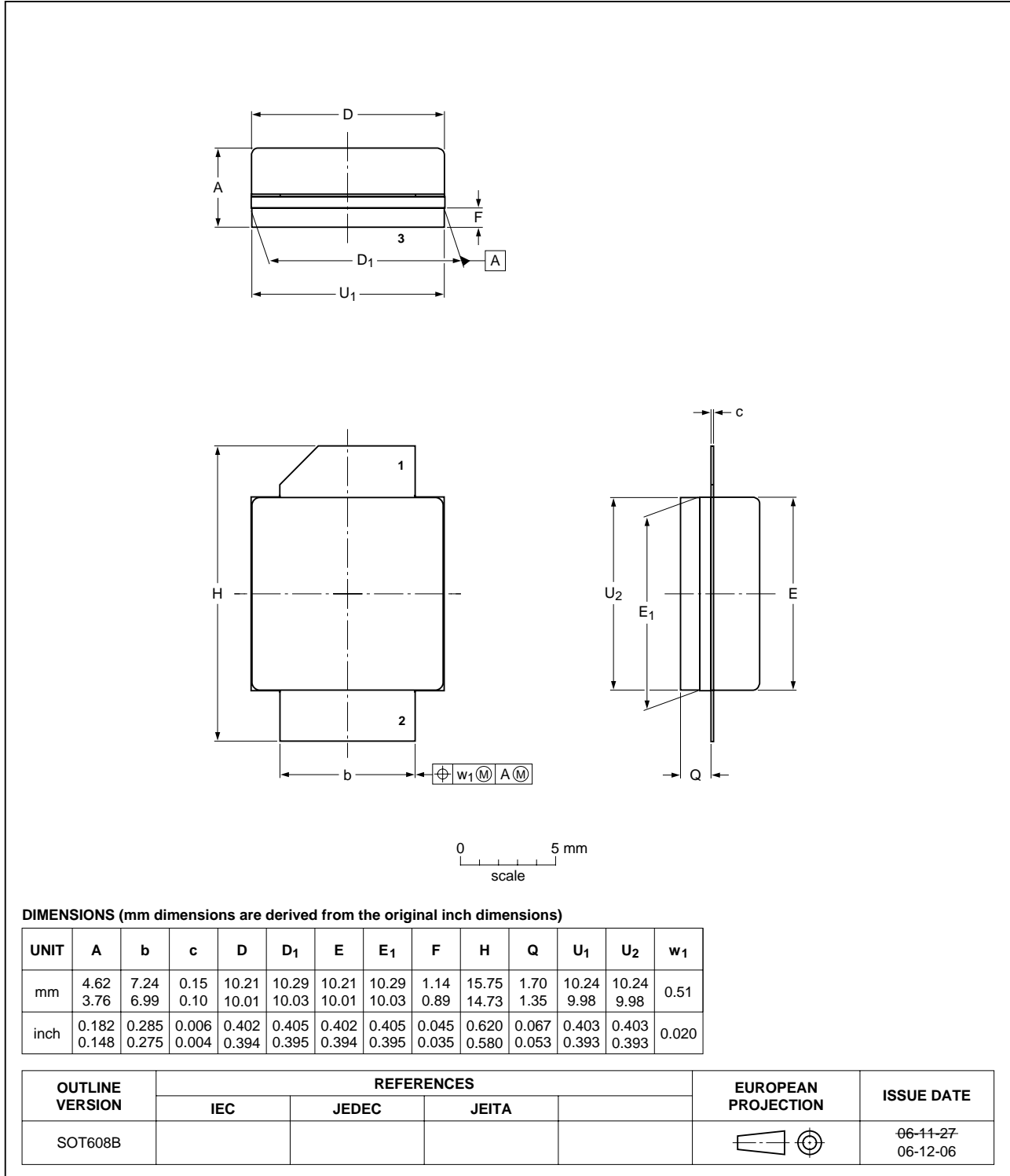

Fig 12. Package outline SOT608B

10. Abbreviations

Table 10. Abbreviations

Acronym	Description
LDMOS	Laterally Diffused Metal Oxide Semiconductor
RF	Radio Frequency
S-Band	Short wave Band
VSWR	Voltage Standing-Wave Ratio

11. Revision history

Table 11. Revision history

Document ID	Release date	Data sheet status	Change notice	Supersedes
BLS6G3135-20_6G3135S-20_3	20090303	Product data sheet	-	BLS6G3135-20_6G3135S-20_2
Modifications:	• Section 7.1 on page 4 : Impedance information added			
BLS6G3135-20_6G3135S-20_2	20081217	Product data sheet	-	BLS6G3135-20_6G3135S-20_1
BLS6G3135-20_6G3135S-20_1	20070307	Objective data sheet	-	-

12. Legal information

12.1 Data sheet status

Document status ^{[1][2]}	Product status ^[3]	Definition
Objective [short] data sheet	Development	This document contains data from the objective specification for product development.
Preliminary [short] data sheet	Qualification	This document contains data from the preliminary specification.
Product [short] data sheet	Production	This document contains the product specification.

[1] Please consult the most recently issued document before initiating or completing a design.

[2] The term 'short data sheet' is explained in section "Definitions".

[3] The product status of device(s) described in this document may have changed since this document was published and may differ in case of multiple devices. The latest product status information is available on the Internet at URL <http://www.nxp.com>.

12.2 Definitions

Draft — The document is a draft version only. The content is still under internal review and subject to formal approval, which may result in modifications or additions. NXP Semiconductors does not give any representations or warranties as to the accuracy or completeness of information included herein and shall have no liability for the consequences of use of such information.

Short data sheet — A short data sheet is an extract from a full data sheet with the same product type number(s) and title. A short data sheet is intended for quick reference only and should not be relied upon to contain detailed and full information. For detailed and full information see the relevant full data sheet, which is available on request via the local NXP Semiconductors sales office. In case of any inconsistency or conflict with the short data sheet, the full data sheet shall prevail.

12.3 Disclaimers

General — Information in this document is believed to be accurate and reliable. However, NXP Semiconductors does not give any representations or warranties, expressed or implied, as to the accuracy or completeness of such information and shall have no liability for the consequences of use of such information.

Right to make changes — NXP Semiconductors reserves the right to make changes to information published in this document, including without limitation specifications and product descriptions, at any time and without notice. This document supersedes and replaces all information supplied prior to the publication hereof.

Suitability for use — NXP Semiconductors products are not designed, authorized or warranted to be suitable for use in medical, military, aircraft, space or life support equipment, nor in applications where failure or

malfunction of an NXP Semiconductors product can reasonably be expected to result in personal injury, death or severe property or environmental damage. NXP Semiconductors accepts no liability for inclusion and/or use of NXP Semiconductors products in such equipment or applications and therefore such inclusion and/or use is at the customer's own risk.

Applications — Applications that are described herein for any of these products are for illustrative purposes only. NXP Semiconductors makes no representation or warranty that such applications will be suitable for the specified use without further testing or modification.

Limiting values — Stress above one or more limiting values (as defined in the Absolute Maximum Ratings System of IEC 60134) may cause permanent damage to the device. Limiting values are stress ratings only and operation of the device at these or any other conditions above those given in the Characteristics sections of this document is not implied. Exposure to limiting values for extended periods may affect device reliability.

Terms and conditions of sale — NXP Semiconductors products are sold subject to the general terms and conditions of commercial sale, as published at <http://www.nxp.com/profile/terms>, including those pertaining to warranty, intellectual property rights infringement and limitation of liability, unless explicitly otherwise agreed to in writing by NXP Semiconductors. In case of any inconsistency or conflict between information in this document and such terms and conditions, the latter will prevail.

No offer to sell or license — Nothing in this document may be interpreted or construed as an offer to sell products that is open for acceptance or the grant, conveyance or implication of any license under any copyrights, patents or other industrial or intellectual property rights.

12.4 Trademarks

Notice: All referenced brands, product names, service names and trademarks are the property of their respective owners.

13. Contact information

For more information, please visit: <http://www.nxp.com>

For sales office addresses, please send an email to: salesaddresses@nxp.com

14. Contents

1	Product profile	1
1.1	General description	1
1.2	Features	1
1.3	Applications	2
2	Pinning information	2
3	Ordering information	2
4	Limiting values	2
5	Thermal characteristics	3
6	Characteristics	3
7	Application information	3
7.1	Impedance information	4
7.2	Ruggedness in class-AB operation	4
7.3	Graphs	5
8	Test information	7
9	Package outline	8
10	Abbreviations	10
11	Revision history	10
12	Legal information	11
12.1	Data sheet status	11
12.2	Definitions	11
12.3	Disclaimers	11
12.4	Trademarks	11
13	Contact information	11
14	Contents	12

Please be aware that important notices concerning this document and the product(s) described herein, have been included in section 'Legal information'.



© NXP B.V. 2009.

All rights reserved.

For more information, please visit: <http://www.nxp.com>

For sales office addresses, please send an email to: salesaddresses@nxp.com

Date of release: 3 March 2009

Document identifier: BLS6G3135-20_6G3135S-20_3