

CLF1G0035S-50

Broadband RF power GaN HEMT

Rev. 4 — 6 November 2014

Objective data sheet

1. Product profile

1.1 General description

CLF1G0035S-50 is a broadband general purpose 50 W amplifier with first generation GaN HEMT technology from NXP. Frequency of operation is from DC to 3.5 GHz.

Table 1. CW and pulsed RF application information

Typical RF performance at $T_{case} = 25\text{ }^{\circ}\text{C}$; $I_{DQ} = 150\text{ mA}$; $V_{DS} = 50\text{ V}$ in a class-AB broadband demo board.

Test signal	f	P _L	G _p	η _D
	(MHz)	(W)	(dB)	(%)
1-Tone CW	500	50	12	64
	1000	50	13	43
	1500	50	13	43
	2000	50	14	43
	2500	50	11	48
1-Tone pulsed [1]	500	50	12	65
	1000	50	15	43
	1500	50	15	43
	2000	50	15	44
	2500	50	13	49

[1] Pulsed RF; $t_p = 100\text{ }\mu\text{s}$; $\delta = 10\text{ }\%$.

Table 2. 2-Tone CW application information

Typical 2-Tone performance at $T_{case} = 25\text{ }^{\circ}\text{C}$; $I_{DQ} = 275\text{ mA}$; $V_{DS} = 50\text{ V}$ in a class-AB broadband demo board.

Test signal	f	P _{L(PEP)}	IMD3
	(MHz)	(W)	(dBc)
2-Tone CW [1]	500	10	-48
	1000	10	-40
	1500	10	-43
	2000	10	-38
	2500	10	-38

[1] 2-Tone CW; $\Delta f = 1\text{ MHz}$.



1.2 Features and benefits

- Frequency of operation is from DC to 3.5 GHz
- 50 W general purpose broadband RF Power GaN HEMT
- Excellent ruggedness (VSWR 10 : 1)
- High voltage operation (50 V)
- Thermally enhanced package

1.3 Applications

- Commercial wireless infrastructure (cellular, WiMAX)
- Industrial, scientific, medical
- Radar
- Jammers
- Broadband general purpose amplifier
- EMC testing
- Public mobile radios
- Defense application

2. Pinning information

Table 3. Pinning

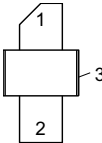
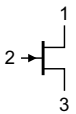
Pin	Description	Simplified outline	Graphic symbol
1	drain		 aaa-003693
2	gate		
3	source [1]		

[1] Connected to flange.

3. Ordering information

Table 4. Ordering information

Type number	Package		
	Name	Description	Version
CLF1G0035S-50	-	earless ceramic package; 2 leads	SOT467B

4. Limiting values

Table 5. Limiting values

In accordance with the Absolute Maximum Rating System (IEC 60134).

Symbol	Parameter	Conditions	Min	Max	Unit
V_{DS}	drain-source voltage		-	150	V
V_{GS}	gate-source voltage		-8	+3	V
I_{GF}	forward gate current	external $R_G = 5 \Omega$	-	18	mA
T_{stg}	storage temperature		-65	+150	°C
T_j	junction temperature	measured via IR scan [1]	-	250	°C

[1] Continuous use at maximum temperature will affect the reliability, for details refer to the on-line MTF calculator.

5. Thermal characteristics

Table 6. Thermal characteristics

Symbol	Parameter	Conditions	Typ	Unit
$R_{th(j-c)}$	thermal resistance from junction to case	$T_j = 200 \text{ °C}$	[1] 2.1	K/W

[1] T_j is measured via IR scan with case temperature of 85 °C and power dissipation of 55 W.

6. Characteristics

Table 7. DC Characteristics

$T_{case} = 25 \text{ °C}$; unless otherwise specified.

Symbol	Parameter	Conditions	Min	Typ	Max	Unit
$V_{(BR)DSS}$	drain-source breakdown voltage	$V_{GS} = -7 \text{ V}$; $I_{DS} = 12 \text{ mA}$	150	-	-	V
$V_{GS(th)}$	gate-source threshold voltage	$V_{DS} = 0.1 \text{ V}$; $I_{DS} = 12 \text{ mA}$	-2.4	-2	-1.3	V
I_{DSX}	drain cut-off current	$V_{DS} = 10 \text{ V}$; $V_{GS} = 3 \text{ V}$	-	8.8	-	A
g_{fs}	forward transconductance	$V_{DS} = 10 \text{ V}$; $V_{GS} = 0 \text{ V}$	-	2.0	-	S

Table 8. RF Characteristics

Test signal: 1-Tone CW; RF performance at $V_{DS} = 50 \text{ V}$; $I_{Dq} = 150 \text{ mA}$; $f = 3 \text{ GHz}$; $T_{case} = 25 \text{ °C}$; unless otherwise specified in a class-AB production circuit.

Symbol	Parameter	Conditions	Min	Typ	Max	Unit
η_D	drain efficiency	$P_L = 50 \text{ W}$	47	54	-	%
G_p	power gain	$P_L = 50 \text{ W}$	9.8	11.5	-	dB
RL_{in}	input return loss	$P_L = 50 \text{ W}$	-	-5	-	dB

7. Application information

7.1 Demo circuit

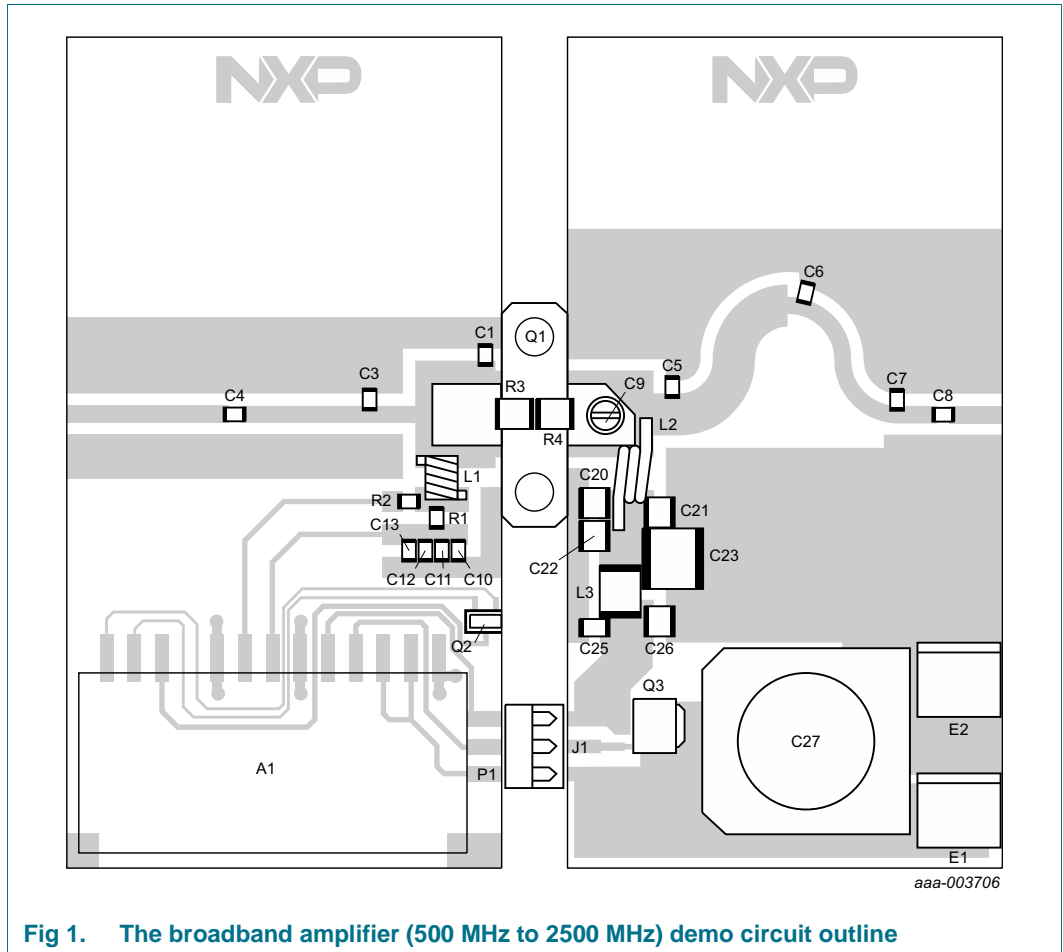

Fig 1. The broadband amplifier (500 MHz to 2500 MHz) demo circuit outline

Table 9. List of components

See [Figure 1](#) and [Figure 2](#)

Component	Description	Value	Remarks
A1	GaN bias module v1	-	NXP
C1	multilayer ceramic chip capacitor	1.5 pF	ATC 600F1R5BT
C3, C6	multilayer ceramic chip capacitor	1.2 pF	ATC 600F1R2BT
C4	multilayer ceramic chip capacitor	5.6 pF	ATC 600F5R6CT
C5	multilayer ceramic chip capacitor	2.2 pF	ATC 600F2R2BT
C7	multilayer ceramic chip capacitor	0.5 pF	ATC 600F0R5BT
C8	multilayer ceramic chip capacitor	20 pF	ATC 600F200JT
C9	capacitor	1 pF to 4 pF	Tronser 66-0304-00004-000
C10	multilayer ceramic chip capacitor	10 nF	generic
C11	multilayer ceramic chip capacitor	22 pF	generic
C12	multilayer ceramic chip capacitor	1 nF	generic

Table 9. List of components ...continued
See [Figure 1](#) and [Figure 2](#)

Component	Description	Value	Remarks
C13	multilayer ceramic chip capacitor	100 nF	generic
C20	multilayer ceramic chip capacitor	1 nF	ATC 100B102KW
C21	multilayer ceramic chip capacitor	100 pF	ATC 100B101JW
C22, C26	multilayer ceramic chip capacitor	10 nF	generic
C23	multilayer ceramic chip capacitor	10 μ F	TDK C5750X7S2A106M
C25	multilayer ceramic chip capacitor	1 μ F	generic
C27	electrolytic capacitor	470 μ F	Panasonic EEE-TK1J471AM
E1, E2	drain voltage connection	-	
J1	RF in connector	-	
J2	RF out connector	-	
J3, P1	1 row, 3-way vertical DC connector header	-	
L1	inductor	12.5 nH	Coil craft A04T
L2	inductor	4 nH	
L3	ferrite bead	-	Fair-Rite 2743019447
Q1	transistor	-	NXP CLF1G0035-50
Q2	transistor	-	NXP BC857B
Q3	transistor	-	NXP PSMN8R2-80YS
R1	resistor,	10 Ω	generic
R2	resistor	10.0 k Ω	generic
R3, R4	resistor	100 Ω	generic
Z1, Z2, Z3, Z4, Z5, Z6	microstrip lines	-	

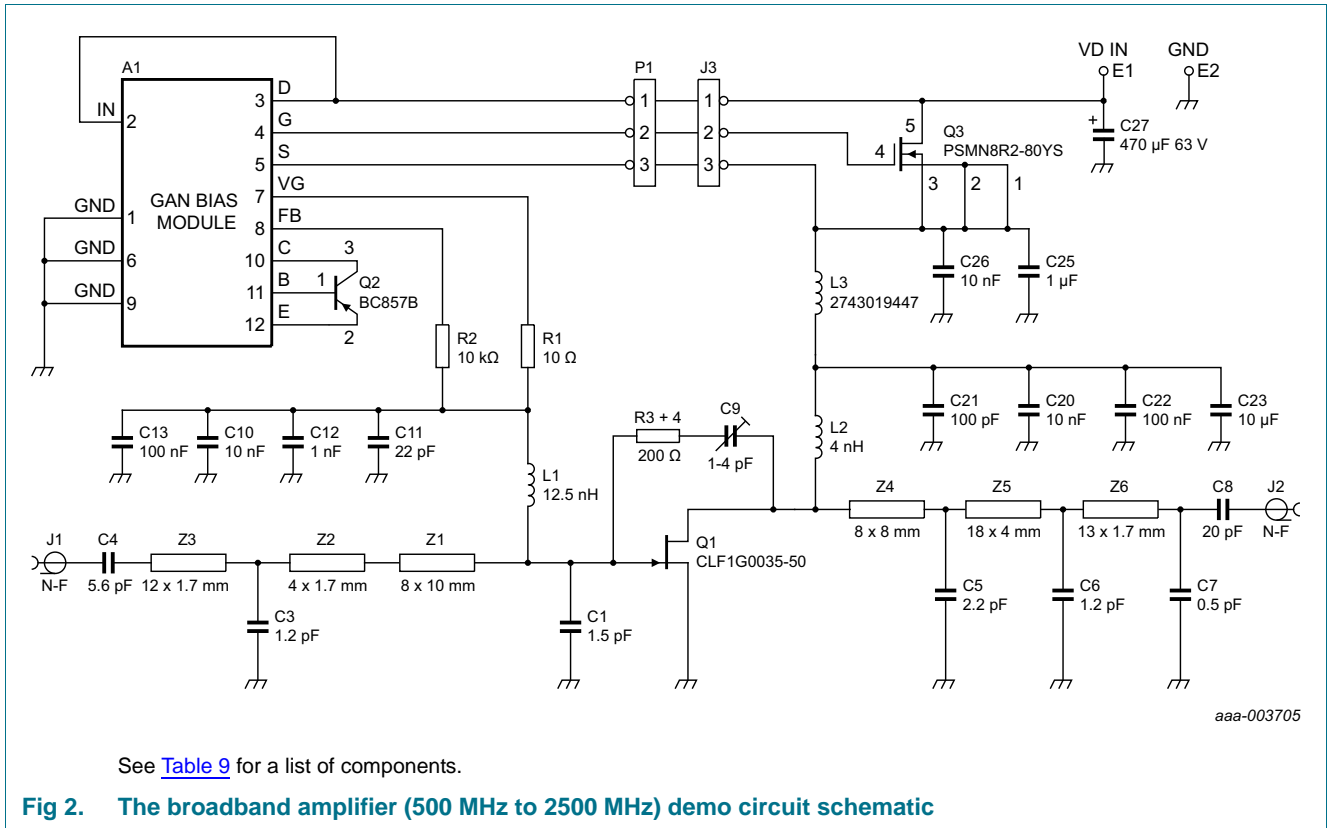

7.2 Application test results

Table 10. CW and pulsed RF application information

Typical RF performance at $T_{case} = 25\text{ }^{\circ}\text{C}$; $I_{Dq} = 150\text{ mA}$; $V_{DS} = 50\text{ V}$ in a class-AB broadband demo board.

Test signal	f (MHz)	P_L (W)	G_p (dB)	η_D (%)
1-Tone CW	500	50	12	64
	1000	50	13	43
	1500	50	13	43
	2000	50	14	43
	2500	50	11	48
1-Tone pulsed [1]	500	50	12	65
	1000	50	15	43
	1500	50	15	43
	2000	50	15	44
	2500	50	13	49

[1] Pulsed RF; $t_p = 100\text{ }\mu\text{s}$; $\delta = 10\text{ }\%$.

Table 11. 2-Tone CW application information

Typical 2-Tone performance at $T_{case} = 25\text{ }^{\circ}\text{C}$; $I_{Dq} = 275\text{ mA}$; $V_{DS} = 50\text{ V}$ in a class-AB broadband demo board.

Test signal	f (MHz)	$P_{L(PEP)}$ (W)	IMD3 (dBc)
2-Tone CW [1]	500	10	-48
	1000	10	-40
	1500	10	-43
	2000	10	-38
	2500	10	-38

[1] 2-Tone CW; $\Delta f = 1\text{ MHz}$.

7.3 Graphical data

The following figures are measured in a broadband amplifier demo board from 500 MHz to 2500 MHz.

7.3.1 1-Tone CW RF performance

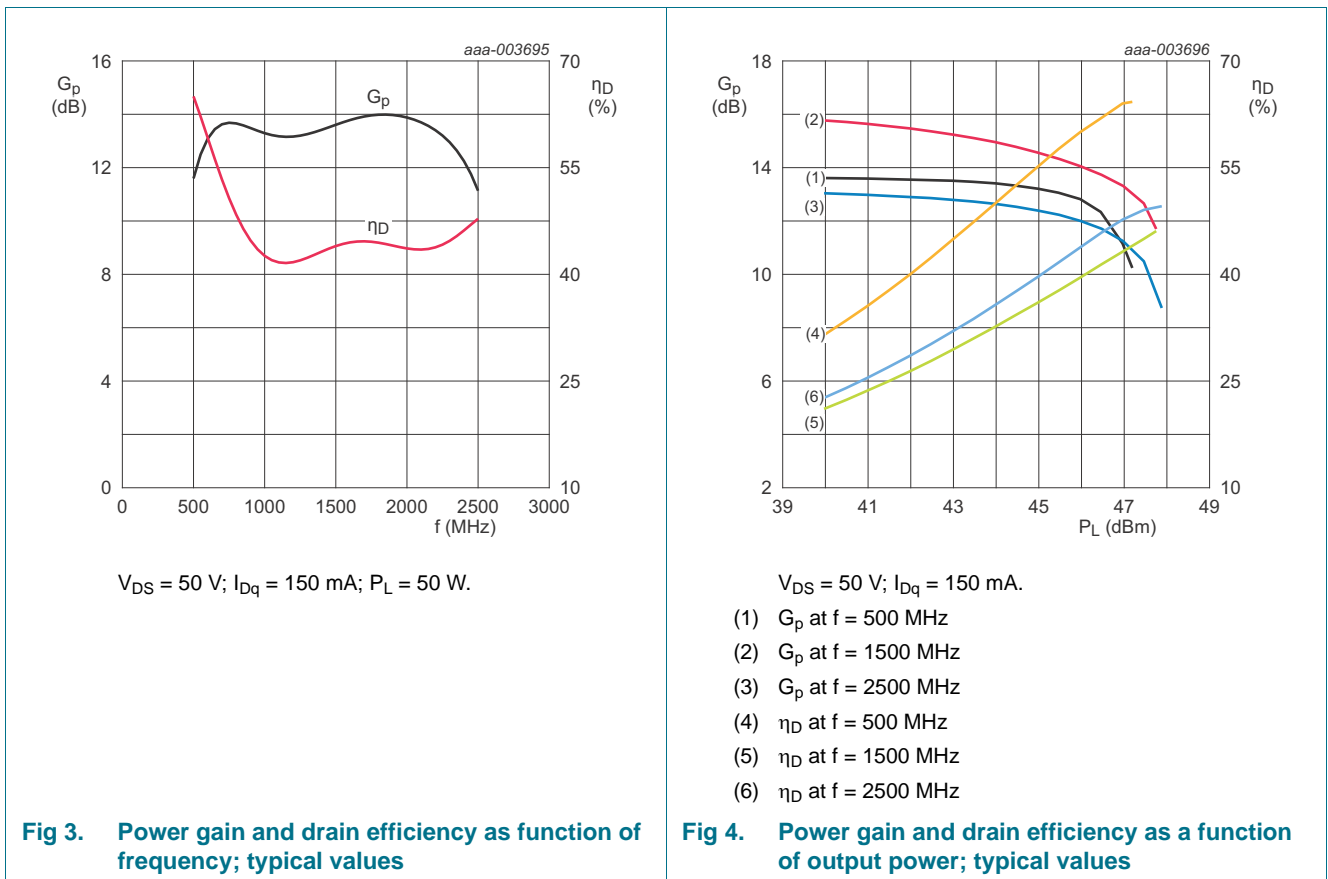

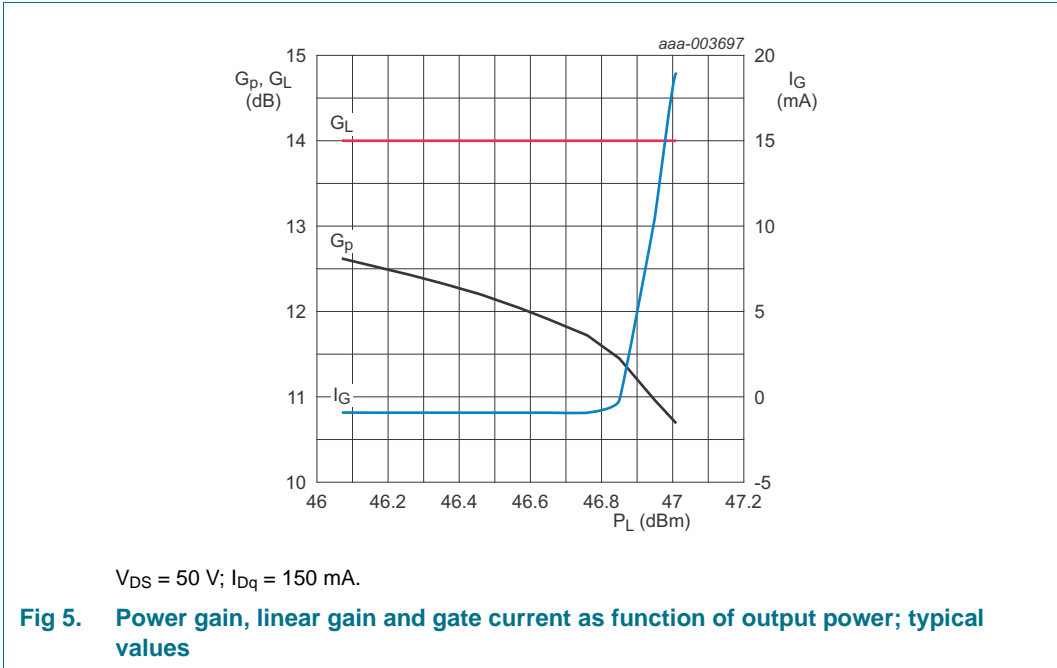

7.3.2 1-Tone pulsed RF performance

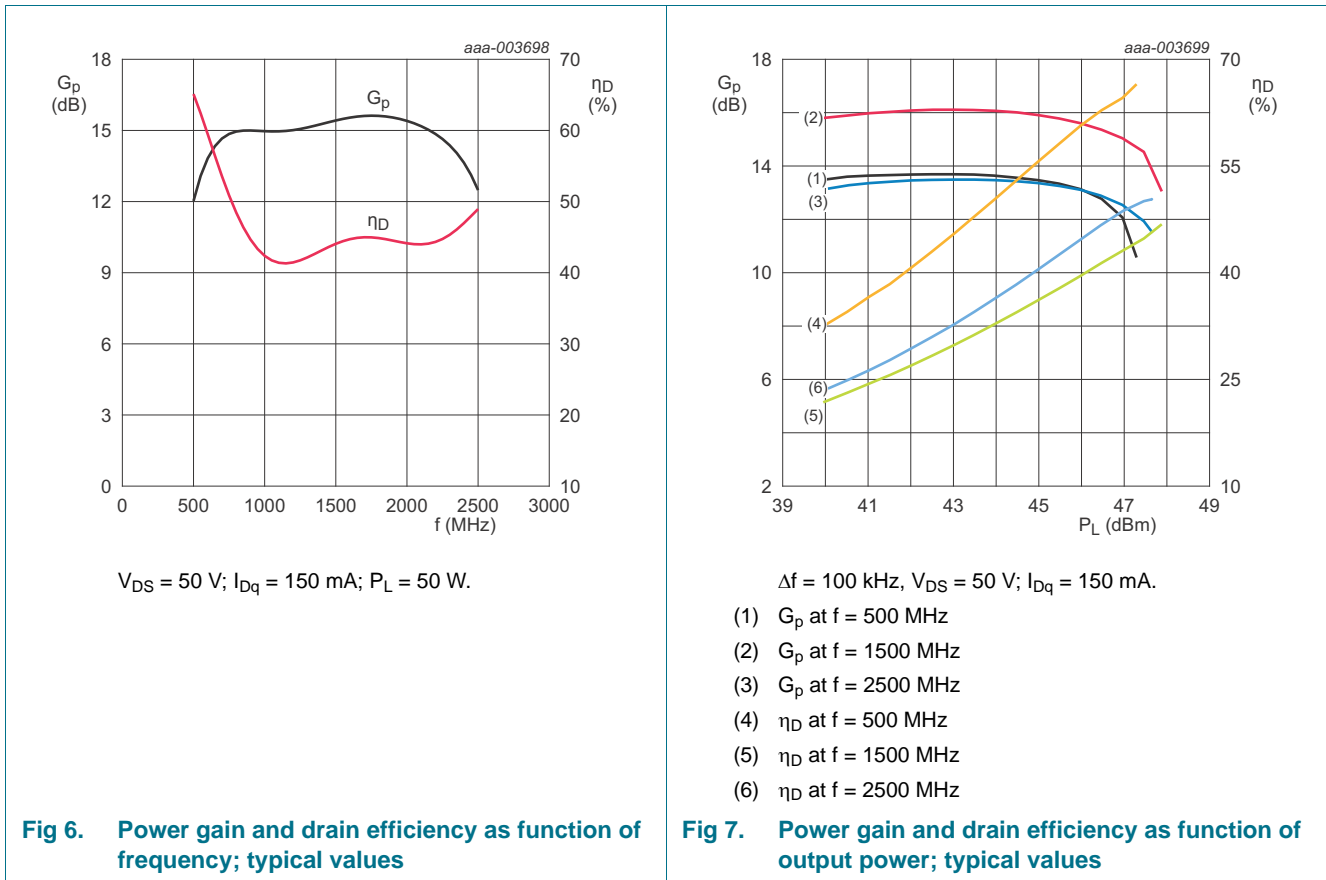

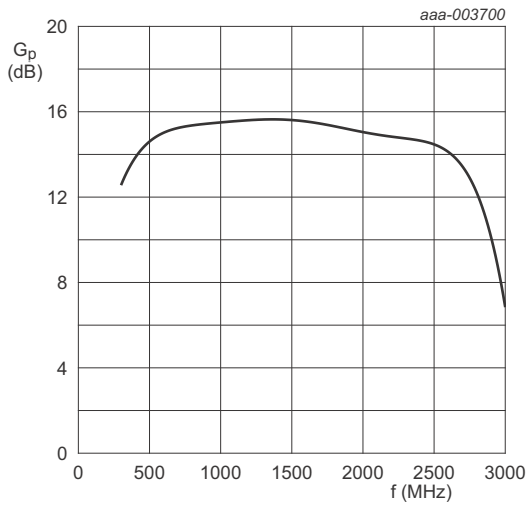

$P_i = 10 \text{ dBm}$, $V_{DS} = 50 \text{ V}$; $I_{Dq} = 150 \text{ mA}$.

Fig 8. Power gain as a function of frequency; typical values

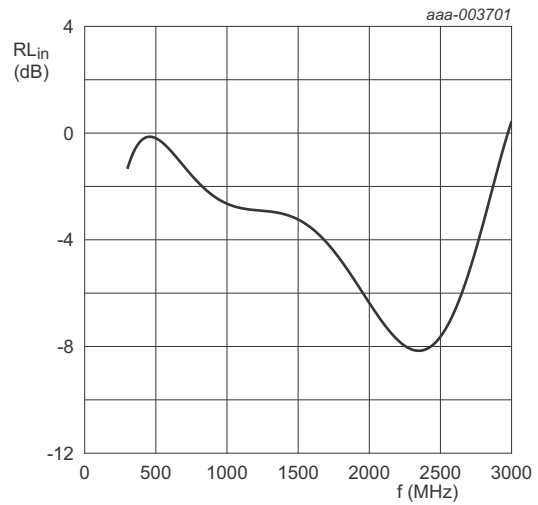

$P_i = 10 \text{ dBm}$, $V_{DS} = 50 \text{ V}$; $I_{Dq} = 150 \text{ mA}$.

Fig 9. Input return loss as a function of frequency; typical values

7.3.3 2-Tone CW performance

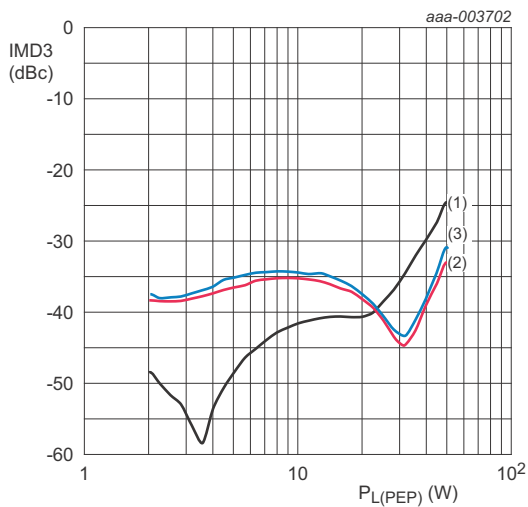

$\Delta f = 1 \text{ MHz}$; $V_{DS} = 50 \text{ V}$; $I_{Dq} = 150 \text{ mA}$.

- (1) $f = 500 \text{ MHz}$
- (2) $f = 1500 \text{ MHz}$
- (3) $f = 2500 \text{ MHz}$

Fig 10. Third-order intermodulation distortion as a function of peak envelope power load power; typical values

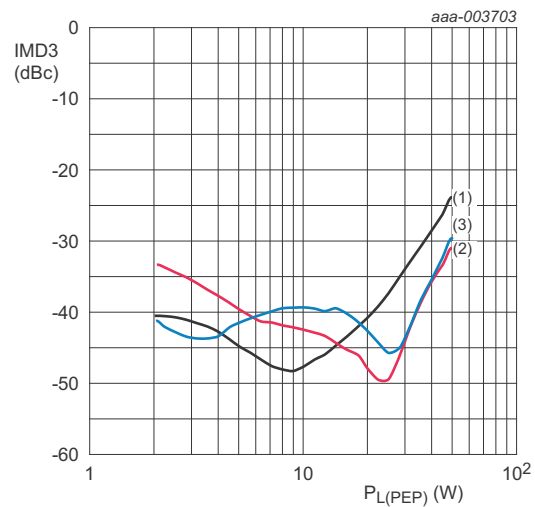

$\Delta f = 1 \text{ MHz}$; $V_{DS} = 50 \text{ V}$; $I_{Dq} = 275 \text{ mA}$.

- (1) $f = 500 \text{ MHz}$
- (2) $f = 1500 \text{ MHz}$
- (3) $f = 2500 \text{ MHz}$

Fig 11. Third-order intermodulation distortion as a function of peak envelope power load power; typical values

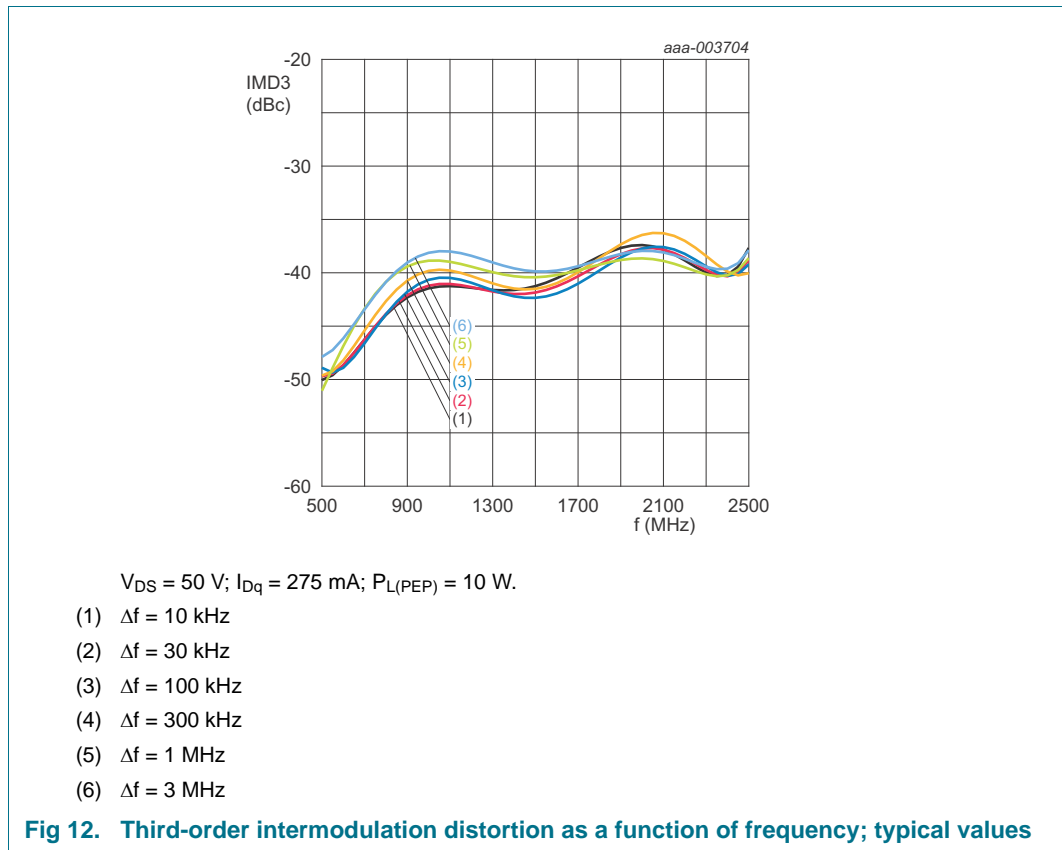

7.4 Bias module

The bias module information for the GaN HEMT amplifier is described in application note AN11130.

8. Test information

8.1 Ruggedness in class-AB operation

The CLF1G0035S-50 is capable of withstanding a load mismatch corresponding to $V_{SWR} = 10 : 1$ through all phases under the following conditions: $V_{DS} = 50 \text{ V}; P_L = 50 \text{ W (CW)}, f = 2500 \text{ MHz}.$

8.2 Load pull impedance information

The measured load pull impedances are shown below. Impedance reference plane defined at device leads. Measurements performed with NXP test fixtures. Test temperature set at $25 \text{ }^\circ\text{C}$ with a CW signal.

Table 12. Typical impedance

Typical values unless otherwise specified.

f (MHz)	Z _S (Ω)	Z _L (maximum P _{L(M)}) (Ω)	Z _L (maximum η _D) (Ω)
500	6.4 + 4j	9.7 + 7j	10 + 5.0j
1000	1.9 + 2.2j	9.1 + 12.4j	10 + 6.0j
2000	1.9 – 2.9j	5 + 4.1j	6.6 + 1.4j
2500	2.1 – 6.3j	3.6 + 0.75j	4.5 – 0.4 j
3000	2.5 – 9j	3.9 – 1.2j	5.8 – 1.8j
3500	2.9 – 14j	6.6 – 2j	5.8 – 3j

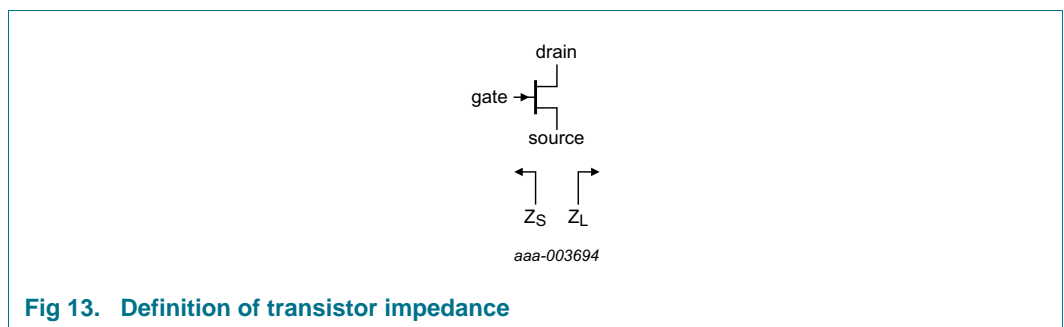

Fig 13. Definition of transistor impedance

Z_S is the measured source pull impedance presented to the device. Z_L is the measured load pull impedance presented to the device.

8.3 Packaged S-parameter data

Table 13. S-parameter

Small signal; $V_{DS} = 50\text{ V}$; $I_{Dq} = 150\text{ mA}$; $Z_S = Z_L = 50\ \Omega$

f (MHz)	S ₁₁		S ₂₁		S ₁₂		S ₂₂	
	Magnitude (ratio)	Angle (degree)	Magnitude (ratio)	Angle (degree)	Magnitude (ratio)	Angle (degree)	Magnitude (ratio)	Angle (degree)
500	0.82686	-168.9	9.6028	67.238	0.01482	-9.5809	0.48482	-133.17
600	0.82717	-171.62	7.7589	61.123	0.013844	-12.463	0.52053	-136.01
700	0.82892	-173.81	6.4386	55.547	0.01282	-14.415	0.55589	-138.65
800	0.83183	-175.69	5.4524	50.412	0.011783	-15.413	0.58964	-141.17
900	0.83572	-177.39	4.6934	45.655	0.010764	-15.358	0.62126	-143.61
1000	0.84047	-178.98	4.096	41.233	0.0097946	-14.091	0.65063	-145.96
1100	0.84604	179.5	3.618	37.11	0.008907	-11.409	0.67787	-148.22
1200	0.85244	178	3.2306	33.257	0.0081421	-7.0907	0.70319	-150.39
1300	0.8597	176.51	2.9136	29.648	0.0075495	-0.99281	0.72687	-152.47
1400	0.86785	175.01	2.6525	26.259	0.0071873	6.7932	0.74919	-154.47
1500	0.87697	173.47	2.4362	23.07	0.0071125	15.766	0.77044	-156.39
1600	0.88715	171.88	2.2569	20.062	0.0073641	25.034	0.79086	-158.24
1700	0.89848	170.23	2.1083	17.22	0.007952	33.645	0.81069	-160.04
1800	0.90446	168.57	1.972	14.461	0.0088014	40.908	0.8252	-161.7
1900	0.90172	166.97	1.839	11.713	0.0098257	46.58	0.83233	-163.2
2000	0.89927	165.33	1.7253	9.0465	0.011062	50.849	0.83898	-164.63
2100	0.89713	163.64	1.6281	6.4503	0.012486	53.942	0.84528	-166
2200	0.89532	161.88	1.5454	3.9129	0.014088	56.092	0.85135	-167.32
2300	0.89386	160.04	1.4755	1.4231	0.015869	57.498	0.85727	-168.6
2400	0.89277	158.1	1.4171	-1.0309	0.01784	58.314	0.86313	-169.84
2500	0.89205	156.03	1.3692	-3.4611	0.020023	58.659	0.86899	-171.05
2600	0.89096	153.83	1.3297	-5.8933	0.022423	58.605	0.87436	-172.23
2700	0.88445	151.58	1.2888	-8.4222	0.024891	58.132	0.87579	-173.35
2800	0.87762	149.17	1.2551	-10.982	0.027588	57.364	0.87715	-174.44
2900	0.87039	146.59	1.2281	-13.588	0.030547	56.329	0.87847	-175.5
3000	0.86268	143.8	1.2076	-16.259	0.033808	55.045	0.8798	-176.54
3100	0.85434	140.75	1.1934	-19.013	0.037423	53.519	0.88118	-177.56
3200	0.84525	137.4	1.1855	-21.877	0.041451	51.748	0.88265	-178.56
3300	0.83522	133.68	1.1839	-24.877	0.045967	49.721	0.88425	-179.53
3400	0.82403	129.52	1.1889	-28.05	0.051058	47.418	0.88607	179.52
3500	0.80856	125.24	1.1872	-31.326	0.056194	44.92	0.88556	178.56
3600	0.79077	120.6	1.1867	-34.765	0.061705	42.174	0.88468	177.6
3700	0.77106	115.45	1.1896	-38.412	0.067742	39.146	0.88406	176.66
3800	0.74926	109.7	1.1956	-42.297	0.074348	35.812	0.88382	175.74
3900	0.72527	103.23	1.2044	-46.449	0.081559	32.146	0.88412	174.82
4000	0.69912	95.917	1.2152	-50.902	0.089394	28.121	0.88516	173.9
4100	0.67108	87.595	1.2274	-55.686	0.097849	23.71	0.88717	172.98

Table 13. S-parameter ...continued

Small signal; $V_{DS} = 50$ V; $I_{Dq} = 150$ mA; $Z_S = Z_L = 50 \Omega$

f (MHz)	S ₁₁		S ₂₁		S ₁₂		S ₂₂	
	Magnitude (ratio)	Angle (degree)	Magnitude (ratio)	Angle (degree)	Magnitude (ratio)	Angle (degree)	Magnitude (ratio)	Angle (degree)
4200	0.64183	78.092	1.24	-60.826	0.10688	18.891	0.89042	172.03
4300	0.6126	67.228	1.2515	-66.34	0.11639	13.65	0.89516	171.03
4400	0.58534	54.856	1.2604	-72.231	0.12622	7.9864	0.90159	169.95
4500	0.5628	40.93	1.2649	-78.48	0.13615	1.9193	0.90984	168.75
4600	0.54816	25.608	1.2633	-85.047	0.14588	-4.5074	0.91983	167.38
4700	0.54433	9.3292	1.2542	-91.862	0.15511	-11.224	0.9313	165.79
4800	0.55279	-7.214	1.2369	-98.835	0.16356	-18.138	0.94381	163.95
4900	0.57293	-23.266	1.2115	-105.86	0.17103	-25.144	0.95677	161.82
5000	0.60219	-38.234	1.1791	-112.84	0.17745	-32.138	0.96962	159.39
5100	0.63534	-51.341	1.1406	-119.47	0.18272	-38.825	0.9807	156.67
5200	0.66527	-61.779	1.0972	-125.31	0.18683	-44.756	0.98704	153.74
5300	0.69493	-71.079	1.0544	-130.96	0.1906	-50.53	0.99214	150.52
5400	0.72195	-78.947	1.0134	-136.23	0.19423	-55.963	0.99508	147.04
5500	0.74577	-85.567	0.97537	-141.15	0.19795	-61.088	0.99579	143.28
5600	0.76759	-91.49	0.94075	-146	0.20193	-66.161	0.99532	139.15
5700	0.78744	-96.798	0.90986	-150.8	0.20632	-71.236	0.99371	134.58
5800	0.80548	-101.57	0.88283	-155.64	0.21125	-76.374	0.99093	129.47
5900	0.82197	-105.86	0.85961	-160.58	0.21682	-81.647	0.98694	123.72
6000	0.83722	-109.72	0.84	-165.71	0.22309	-87.14	0.98164	117.18

9. Package outline

Earless ceramic package; 2 leads

SOT467B

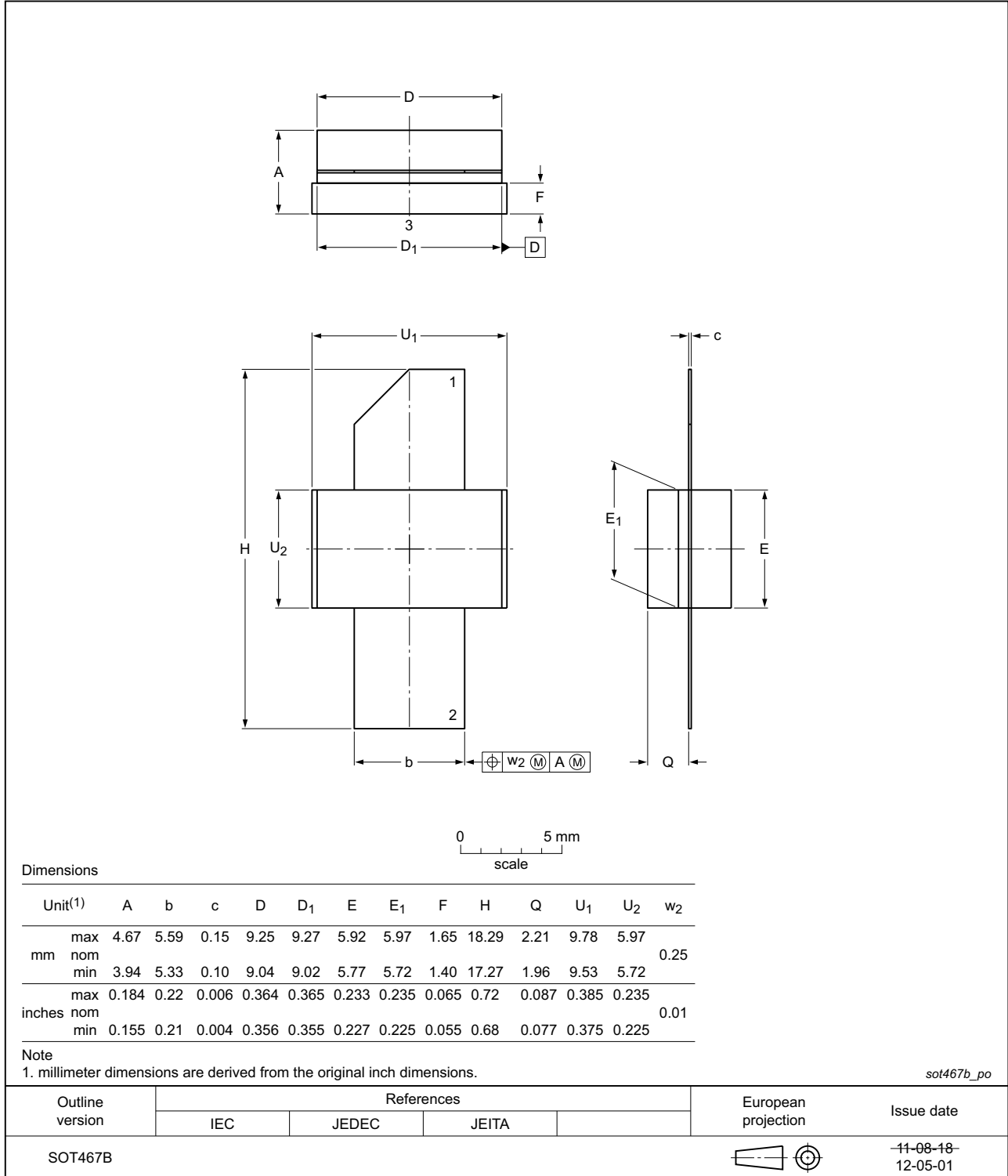

Fig 14. Package outline SOT467B

10. Handling information

10.1 ESD Sensitivity

Table 14. ESD sensitivity

ESD model	Class
Human Body Model (HBM); According JEDEC standard JESD22-A114F	1B [1]

[1] Classification 1B is granted to any part that passes after exposure to an ESD pulse of 500 V, but fails after exposure to an ESD pulse of 1000 V.

11. Abbreviations

Table 15. Abbreviations

Acronym	Description
CW	Continuous Wave
EMC	ElectroMagnetic Compatibility
ESD	ElectroStatic Discharge
GaN	Gallium Nitride
HEMT	High Electron Mobility Transistor
MTF	Median Time to Failure
VSWR	Voltage Standing-Wave Ratio
WiMAX	Worldwide Interoperability for Microwave Access

12. Revision history

Table 16. Revision history

Document ID	Release date	Data sheet status	Change notice	Supersedes
CLF1G0035S-50 v.4	20141106	Objective data sheet	-	CLF1G0035-50_1G0035S-50 v.3
Modifications:	<ul style="list-style-type: none"> The document now describes only the earless version of this product: CLF1G0035S-50. 			
CLF1G0035-50_1G0035S-50 v.3	20140926	Objective data sheet	-	CLF1G0035-50_1G0035S-50 v.2
CLF1G0035-50_1G0035S-50 v.2	20130129	Objective data sheet	-	CLF1G0035-50_1G0035S-50 v.1
CLF1G0035-50_1G0035S-50 v.1	20120615	Objective data sheet	-	-

13. Legal information

13.1 Data sheet status

Document status ^{[1][2]}	Product status ^[3]	Definition
Objective [short] data sheet	Development	This document contains data from the objective specification for product development.
Preliminary [short] data sheet	Qualification	This document contains data from the preliminary specification.
Product [short] data sheet	Production	This document contains the product specification.

[1] Please consult the most recently issued document before initiating or completing a design.

[2] The term 'short data sheet' is explained in section "Definitions".

[3] The product status of device(s) described in this document may have changed since this document was published and may differ in case of multiple devices. The latest product status information is available on the Internet at URL <http://www.nxp.com>.

13.2 Definitions

Draft — The document is a draft version only. The content is still under internal review and subject to formal approval, which may result in modifications or additions. NXP Semiconductors does not give any representations or warranties as to the accuracy or completeness of information included herein and shall have no liability for the consequences of use of such information.

Short data sheet — A short data sheet is an extract from a full data sheet with the same product type number(s) and title. A short data sheet is intended for quick reference only and should not be relied upon to contain detailed and full information. For detailed and full information see the relevant full data sheet, which is available on request via the local NXP Semiconductors sales office. In case of any inconsistency or conflict with the short data sheet, the full data sheet shall prevail.

Product specification — The information and data provided in a Product data sheet shall define the specification of the product as agreed between NXP Semiconductors and its customer, unless NXP Semiconductors and customer have explicitly agreed otherwise in writing. In no event however, shall an agreement be valid in which the NXP Semiconductors product is deemed to offer functions and qualities beyond those described in the Product data sheet.

13.3 Disclaimers

Limited warranty and liability — Information in this document is believed to be accurate and reliable. However, NXP Semiconductors does not give any representations or warranties, expressed or implied, as to the accuracy or completeness of such information and shall have no liability for the consequences of use of such information. NXP Semiconductors takes no responsibility for the content in this document if provided by an information source outside of NXP Semiconductors.

In no event shall NXP Semiconductors be liable for any indirect, incidental, punitive, special or consequential damages (including - without limitation - lost profits, lost savings, business interruption, costs related to the removal or replacement of any products or rework charges) whether or not such damages are based on tort (including negligence), warranty, breach of contract or any other legal theory.

Notwithstanding any damages that customer might incur for any reason whatsoever, NXP Semiconductors' aggregate and cumulative liability towards customer for the products described herein shall be limited in accordance with the *Terms and conditions of commercial sale* of NXP Semiconductors.

Right to make changes — NXP Semiconductors reserves the right to make changes to information published in this document, including without limitation specifications and product descriptions, at any time and without notice. This document supersedes and replaces all information supplied prior to the publication hereof.

Suitability for use — NXP Semiconductors products are not designed, authorized or warranted to be suitable for use in life support, life-critical or safety-critical systems or equipment, nor in applications where failure or malfunction of an NXP Semiconductors product can reasonably be expected to result in personal injury, death or severe property or environmental damage. NXP Semiconductors and its suppliers accept no liability for inclusion and/or use of NXP Semiconductors products in such equipment or applications and therefore such inclusion and/or use is at the customer's own risk.

Applications — Applications that are described herein for any of these products are for illustrative purposes only. NXP Semiconductors makes no representation or warranty that such applications will be suitable for the specified use without further testing or modification.

Customers are responsible for the design and operation of their applications and products using NXP Semiconductors products, and NXP Semiconductors accepts no liability for any assistance with applications or customer product design. It is customer's sole responsibility to determine whether the NXP Semiconductors product is suitable and fit for the customer's applications and products planned, as well as for the planned application and use of customer's third party customer(s). Customers should provide appropriate design and operating safeguards to minimize the risks associated with their applications and products.

NXP Semiconductors does not accept any liability related to any default, damage, costs or problem which is based on any weakness or default in the customer's applications or products, or the application or use by customer's third party customer(s). Customer is responsible for doing all necessary testing for the customer's applications and products using NXP Semiconductors products in order to avoid a default of the applications and the products or of the application or use by customer's third party customer(s). NXP does not accept any liability in this respect.

Limiting values — Stress above one or more limiting values (as defined in the Absolute Maximum Ratings System of IEC 60134) will cause permanent damage to the device. Limiting values are stress ratings only and (proper) operation of the device at these or any other conditions above those given in the Recommended operating conditions section (if present) or the Characteristics sections of this document is not warranted. Constant or repeated exposure to limiting values will permanently and irreversibly affect the quality and reliability of the device.

Terms and conditions of commercial sale — NXP Semiconductors products are sold subject to the general terms and conditions of commercial sale, as published at <http://www.nxp.com/profile/terms>, unless otherwise agreed in a valid written individual agreement. In case an individual agreement is concluded only the terms and conditions of the respective agreement shall apply. NXP Semiconductors hereby expressly objects to applying the customer's general terms and conditions with regard to the purchase of NXP Semiconductors products by customer.

No offer to sell or license — Nothing in this document may be interpreted or construed as an offer to sell products that is open for acceptance or the grant, conveyance or implication of any license under any copyrights, patents or other industrial or intellectual property rights.

Export control — This document as well as the item(s) described herein may be subject to export control regulations. Export might require a prior authorization from competent authorities.

Non-automotive qualified products — Unless this data sheet expressly states that this specific NXP Semiconductors product is automotive qualified, the product is not suitable for automotive use. It is neither qualified nor tested in accordance with automotive testing or application requirements. NXP Semiconductors accepts no liability for inclusion and/or use of non-automotive qualified products in automotive equipment or applications.

In the event that customer uses the product for design-in and use in automotive applications to automotive specifications and standards, customer (a) shall use the product without NXP Semiconductors' warranty of the product for such automotive applications, use and specifications, and (b) whenever customer uses the product for automotive applications beyond

NXP Semiconductors' specifications such use shall be solely at customer's own risk, and (c) customer fully indemnifies NXP Semiconductors for any liability, damages or failed product claims resulting from customer design and use of the product for automotive applications beyond NXP Semiconductors' standard warranty and NXP Semiconductors' product specifications.

Translations — A non-English (translated) version of a document is for reference only. The English version shall prevail in case of any discrepancy between the translated and English versions.

13.4 Trademarks

Notice: All referenced brands, product names, service names and trademarks are the property of their respective owners.

14. Contact information

For more information, please visit: <http://www.nxp.com>

For sales office addresses, please send an email to: salesaddresses@nxp.com

15. Contents

1	Product profile	1
1.1	General description	1
1.2	Features and benefits	2
1.3	Applications	2
2	Pinning information	2
3	Ordering information	2
4	Limiting values	3
5	Thermal characteristics	3
6	Characteristics	3
7	Application information	4
7.1	Demo circuit	4
7.2	Application test results	6
7.3	Graphical data	7
7.3.1	1-Tone CW RF performance	7
7.3.2	1-Tone pulsed RF performance	8
7.3.3	2-Tone CW performance	9
7.4	Bias module	10
8	Test information	10
8.1	Ruggedness in class-AB operation	10
8.2	Load pull impedance information	10
8.3	Packaged S-parameter data	12
9	Package outline	14
10	Handling information	15
10.1	ESD Sensitivity	15
11	Abbreviations	15
12	Revision history	15
13	Legal information	16
13.1	Data sheet status	16
13.2	Definitions	16
13.3	Disclaimers	16
13.4	Trademarks	17
14	Contact information	17
15	Contents	18

Please be aware that important notices concerning this document and the product(s) described herein, have been included in section 'Legal information'.

© NXP Semiconductors N.V. 2014.

All rights reserved.

For more information, please visit: <http://www.nxp.com>

For sales office addresses, please send an email to: salesaddresses@nxp.com

Date of release: 6 November 2014

Document identifier: CLF1G0035S-50